



X10SRW-F

USER'S MANUAL

Revision 1.1c

The information in this User's Manual has been carefully reviewed and is believed to be accurate. The vendor assumes no responsibility for any inaccuracies that may be contained in this document, makes no commitment to update or to keep current the information in this manual, or to notify any person or organization of the updates. **Please Note: For the most up-to-date version of this manual, please see our web site at www.supermicro.com.**

Super Micro Computer, Inc. ("Supermicro") reserves the right to make changes to the product described in this manual at any time and without notice. This product, including software and documentation, is the property of Supermicro and/or its licensors, and is supplied only under a license. Any use or reproduction of this product is not allowed, except as expressly permitted by the terms of said license.

IN NO EVENT WILL SUPERMICRO BE LIABLE FOR DIRECT, INDIRECT, SPECIAL, INCIDENTAL, SPECULATIVE OR CONSEQUENTIAL DAMAGES ARISING FROM THE USE OR INABILITY TO USE THIS PRODUCT OR DOCUMENTATION, EVEN IF ADVISED OF THE POSSIBILITY OF SUCH DAMAGES. IN PARTICULAR, SUPERMICRO SHALL NOT HAVE LIABILITY FOR ANY HARDWARE, SOFTWARE, OR DATA STORED OR USED WITH THE PRODUCT, INCLUDING THE COSTS OF REPAIRING, REPLACING, INTEGRATING, INSTALLING OR RECOVERING SUCH HARDWARE, SOFTWARE, OR DATA.

Any disputes arising between manufacturer and customer shall be governed by the laws of Santa Clara County in the State of California, USA. The State of California, County of Santa Clara shall be the exclusive venue for the resolution of any such disputes. Super Micro's total liability for all claims will not exceed the price paid for the hardware product.

FCC Statement: This equipment has been tested and found to comply with the limits for a class B digital device, pursuant to Part 15 of the FCC Rules. These limits are designed to provide reasonable protection against harmful interference in a residential installation. This equipment generates, uses, and can radiate radio frequency energy and, if not installed and used in accordance with the instructions, may cause harmful interference to radio communications. However, there is no guarantee that interference will not occur in a particular installation. If this equipment does cause harmful interference to radio or television reception, which can be determined by turning the equipment off and on, the user is encouraged to try to correct the interference by one or more of the following measures:

- Reorient or relocate the receiving antenna.
- Increase the separation between the equipment and receiver.
- Connect the equipment to an outlet on a circuit different from that to which the receiver is connected.
- Consult the authorized dealer or an experienced radio/TV technician for help.

California Best Management Practices Regulations for Perchlorate Materials: This Perchlorate warning applies only to products containing CR (Manganese Dioxide) Lithium coin cells. "Perchlorate Material-special handling may apply. See www.dtsc.ca.gov/hazardouswaste/perchlorate"

WARNING: Handling of lead solder materials used in this product may expose you to lead, a chemical known to the State of California to cause birth defects and other reproductive harm.

Manual Revision 1.1c

Release Date: April 18th, 2019

Unless you request and receive written permission from Super Micro Computer, Inc., you may not copy any part of this document.

Information in this document is subject to change without notice. Other products and companies referred to herein are trademarks or registered trademarks of their respective companies or mark holders.

Copyright © 2019 by Super Micro Computer, Inc.

All rights reserved.

Printed in the United States of America

Preface

This manual is written for system integrators, IT professionals, and knowledgeable end users. It provides information for the installation and use of the **SUPER** X10SRW-F motherboard.

About This Motherboard

The **SUPER** X10SRW-F supports a single Intel® E5-2600/1600 Series Processor in an LGA2011 R3 socket. With the Intel® C612 Express chipset built in, the X10SRW-F motherboard supports Intel® Server Platform Services (Intel SPS), offering great system enhancement to high performance storage platforms. Please refer to our website (<http://www.supermicro.com/products/>) for processor and memory support updates. This product is intended to be installed and serviced by professional technicians.

Manual Organization

Chapter 1 describes the features, specifications and performance of the motherboard, and provides detailed information on the Intel® C612 Express chipset.

Chapter 2 provides hardware installation instructions. Read this chapter when installing the processor, memory modules and other hardware components into the system. If you encounter any problems, see **Chapter 3**, which describes troubleshooting procedures for video, memory and system setup stored in the CMOS.

Chapter 4 includes an introduction to the BIOS, and provides detailed information on running the CMOS Setup utility.

Appendix A provides BIOS Error Beep Codes.

Appendix B lists software program installation instructions.

Appendix C contains UEFI BIOS Recovery instructions.

Appendix D contains Dual Boot Block instructions.

Conventions Used in the Manual:

Special attention should be given to the following symbols for proper system installation:

Warning: Critical information given to prevent damage to the components or injury to yourself.



Note: Additional Information provided for correct system setup.

Contacting Supermicro

Headquarters

Address: Super Micro Computer, Inc.
980 Rock Ave.
San Jose, CA 95131 U.S.A.

Tel: +1 (408) 503-8000

Fax: +1 (408) 503-8008

Email: marketing@supermicro.com (General Information)
support@supermicro.com (Technical Support)

Website: www.supermicro.com

Europe

Address: Super Micro Computer B.V.
Het Sterrenbeeld 28, 5215 ML
's-Hertogenbosch, The Netherlands

Tel: +31 (0) 73-6400390

Fax: +31 (0) 73-6416525

Email: sales@supermicro.nl (General Information)
support@supermicro.nl (Technical Support)
rma@supermicro.nl (Customer Support)

Website: www.supermicro.nl

Asia-Pacific

Address: Super Micro Computer, Inc.
3F, No. 150, Jian 1st Rd.
Zhonghe Dist., New Taipei City 235
Taiwan (R.O.C)

Tel: +886-(2) 8226-3990

Fax: +886-(2) 8226-3992

Email: support@supermicro.com.tw

Website: www.supermicro.com.tw

Table of Contents

Preface

About This Motherboard.....	iii
Manual Organization	iii
Conventions Used in the Manual:.....	iv
Contacting Supermicro.....	v

Chapter 1 Introduction

1-1 Overview	1-1
Checklist.....	1-1
Motherboard Features.....	1-7
1-2 Chipset Overview	1-10
1-3 Special Features	1-11
1-4 PC Health Monitoring.....	1-11
1-5 ACPI Features.....	1-12
1-6 Power Supply.....	1-12
1-7 Super I/O.....	1-13

Chapter 2 Installation

2-1 Standardized Warning Statements	2-1
2-2 Static-Sensitive Devices.....	2-4
2-3 Motherboard Installation.....	2-5
2-4 Processor and Heatsink Installation.....	2-7
2-5 Installing DDR4 Memory	2-13
2-6 Connectors/IO Ports.....	2-17
2-7 Connecting Cables.....	2-26
2-8 Jumper Settings	2-32
2-9 Onboard Indicators.....	2-36
2-10 SATA Connections.....	2-39

Chapter 3 Troubleshooting

3-1 Troubleshooting Procedures	3-1
3-2 Technical Support Procedures.....	3-3
3-3 Frequently Asked Questions.....	3-4
3-4 Battery Removal and Installation.....	3-5
3-5 Returning Merchandise for Service.....	3-6

Chapter 4 UEFI BIOS

4-1 Introduction.....	4-1
4-3 Advanced Setup Configurations.....	4-4

4-4	Event Logs	4-33
4-5	IPMI	4-35
4-6	Security Settings	4-38
4-7	Boot Settings	4-39
4-8	Save & Exit	4-41
Appendix A UEFI BIOS Error Beep Codes		
A-1	BIOS Error Beep Codes	A-1
Appendix B Software Installation Instructions		
B-1	Installing Software Programs	B-1
B-2	Installing SuperDoctor5	B-2
Appendix C UEFI BIOS Recovery Instructions		
C-1	An Overview to the UEFI BIOS	C-1
C-2	How to Recover the UEFI BIOS Image (-the Main BIOS Block).....	C-1
C-3	To Recover the Main BIOS Block Using a USB-Attached Device.....	C-1
Appendix D Dual Boot Block on Grantley Platforms		
	Overview.....	D-1
	Before Startup	D-1
	When to Use Dual Boot Block	D-1
	How to Use Dual Boot Block.....	D-1
D-1	IPMI GUI Browser	D-2
D-2	IPMI Command Sets.....	D-7
	User Approach.....	D-9

Notes

Chapter 1

Introduction

1-1 Overview

Checklist

Congratulations on purchasing your computer motherboard from an acknowledged leader in the industry. Supermicro boards are designed with the utmost attention to detail to provide you with the highest standards in quality and performance.

Please check that the following items have all been included with your motherboard. If anything listed here is damaged or missing, contact your retailer.

The following items are included in the retail box:

- One (1) Supermicro Motherboard
- Ten (10) SATA cables
- One (1) I/O shield
- One (1) Quick Reference Guide



Note: For your system to work properly, please follow the links below to download all necessary drivers/utilities and the user's manual for your motherboard.

Supermicro product manuals: <http://www.supermicro.com/support/manuals/>

Product Drivers and utilities: <https://www.supermicro.com/wftp/driver>

If you have any questions, please contact our support team at support@supermicro.com.

SUPER[®] X10SRW-F Motherboard Image

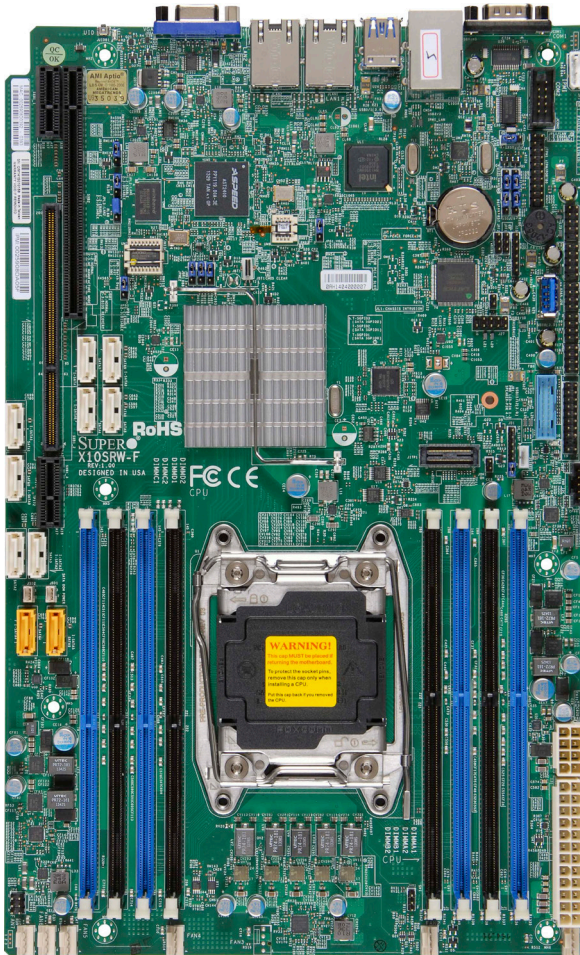

 **Note:** All graphics shown in this manual were based upon the latest PCB Revision available at the time of publishing of the manual. Your motherboard or components may or may not look exactly the same as the graphics shown in this manual.

X10SRW-F Motherboard Layout

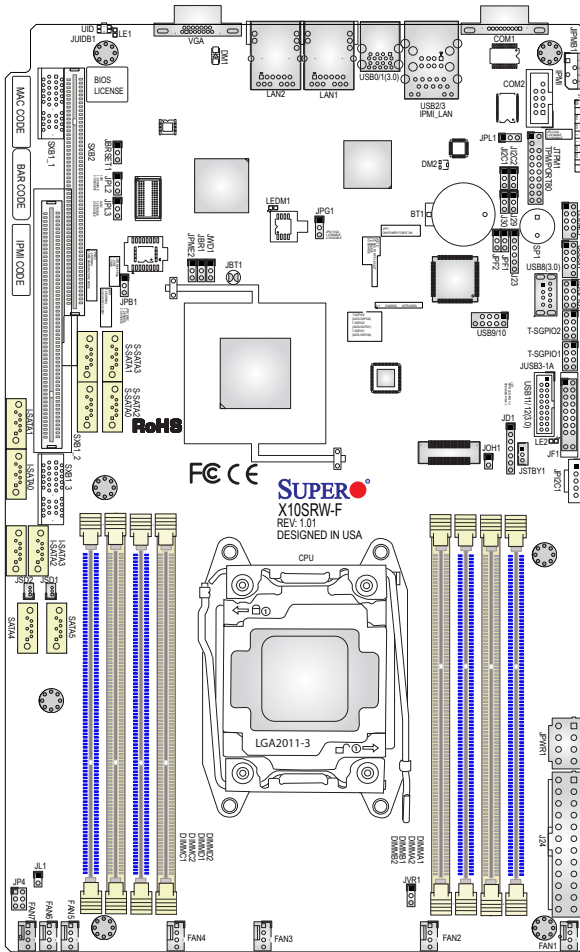

 **Notes:**

- See Chapter 2 for detailed information on jumpers, I/O ports and JF1 front panel connections.
- "■" indicates the location of "Pin 1".
- Jumpers not indicated are for testing only.
- When the onboard Power LED Indicator (LE2) is on, system power is on. Unplug the power cable before installing or removing any components.

X10SRW-F Quick Reference

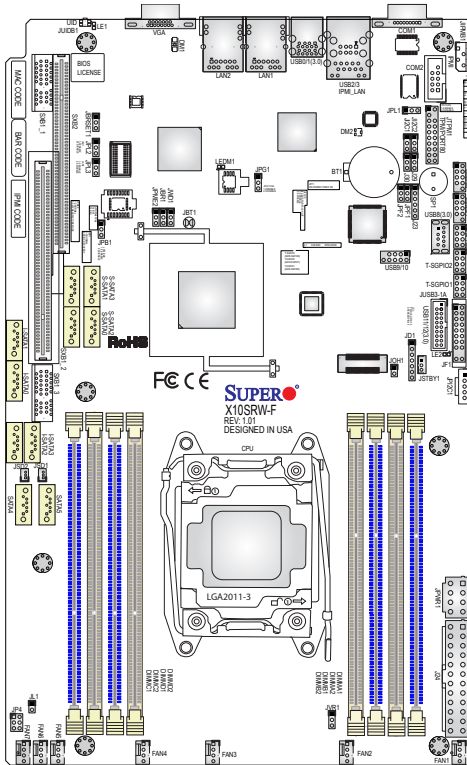

X10SRW-F Jumpers

Jumper	Description	Default
JBR1	BIOS Recovery	Pins 1-2 (Normal)
JBRSET1	FIQ Request	Pins 1-2 (Normal)
JBT1	CMOS Clear	Short: Clear CMOS, Open: Normal Operation
J12C1/J12C2	SMB to PCI-E Slots	Pins 2-3 (Disabled)
JPB1	BMC Enable/Disable	Pins 1-2 (Enabled)
JPG1	VGA Enable	Pins 1-2 (Enabled)
JPL1	LAN Enable	Pins 1-2 (Enabled)
JWD1	Watch Dog Enable	Pins 1-2 (Reset)

X10SRW-F Headers/Connectors	
Connector	Description
BT1	Onboard Battery
COM1/COM2	COM1 (Port)/COM2 (Header)
FAN1-2, FAN4-7	System/CPU Fan Headers
J24	24-pin Main ATX Power Connector
JD1	Speaker/Buzzer (Pins 1-3: Power LED, Pins 4-7: Speaker)
JF1	Front Control Panel Header
JIPMB1	System Management Bus Header for the IPMI Slot
JL1	Chassis Intrusion Header
JOH1	Overheat LED/Fan Fail
JPI ² C1	Power SMB (System Management Bus)
JPWR1	8-pin CPU Power Connector
JSD1/JSD2	SATA DOM (Device On Module) Power Connector
JSTBY1	Standby Power Header
JTPM1	Trusted Platform Module/Port 80 Connector
JUIDB1	UID (Unit Identification) Switch
JVR1	PWM SMB Programming (for debugging only)
LAN1/LAN2	Gigabit (RJ45) Ports (LAN1/2)
IPMI_LAN	Dedicated IPMI LAN
I-SATA 0-3 S-SATA 0-3	(Intel PCH) Serial ATA (SATA 3.0) Ports 0-3 S-SATA Ports 0-3 (6Gb/sec)
SATA 4/5	SATA DOM (Disk On Module) Ports 4/5
SP1	Internal Speaker/Buzzer
SXB1A, SXB1B, SXB1C	SMC-Proprietary WIO_L (Left) Add-On Card slots
SXB2	SMC-Proprietary WIO_R (Right) Add-On Card slot
T-SGPIO 1/2/3	Serial Link General Purpose I/O Headers 1/2/3 for SATA Connections T-SGPIO1: For I-SATA 0-3 T-SGPIO2: For I-SATA 4-5 T-SGPIO3: For S-SATA 0-3
UID SW	Unit Identifier Switch
USB 0/1	Back Panel USB 3.0 Ports 0/1
USB 2/3	Back Panel USB 2.0 Ports 2/3
USB 4/5, 6/7, 9/10	Front Panel Accessible USB 2.0 Headers 4/5, 6/7, 9/10
USB 8	USB 3.0 Type A Header
USB 11/12 (3.0)	Front Panel Accessible USB 3.0 Port 11/12
VGA	Back Panel VGA Port

X10SRW-F LED Indicators			
LED	Description	State/Color	Status
LE1	UID LED	Blue: On	Unit Identified
LEDM1	BMC Heartbeat LED	Green: Blinking	BMC Normal

Motherboard Features

CPU	Single Intel® E5-2600/1600 Series Processor in an LGA2011 R3 socket.  Note: Both E5-2600v4 and E5-1600v4 require Revision 2.0 BIOS (or higher).	
Memory	Eight (8) ECC DDR4 RDIMM/LRDIMM/UDIMM at 2400 MHz (max.) memory (1 DPC) up to 256GB RDIMM, 512GB LRDIMM, or 64GB UDIMM.	
	Dual-channel memory	
	DIMM sizes	
	RDIMM	1GB, 2 GB, 4GB, 8GB, 16GB, and 32GB
Chipset	Intel® C612 Express	
Expansion Slots	PCI Slots	
	One (1) SMC-Proprietary WIO Left Add-On card slot	
	One (1) standard PCIe Right Add-On card slot	
	Two (2) RJ-45 rear I/O panel connectors with Link and Activity LEDs	
Network	Intel i350 Dual Gigabit LAN controller	
I/O Devices	SATA Connections	
	SATA 3.0 (6Gb/s)	Ten (10) SATA ports
		<ul style="list-style-type: none"> AHCI controller supports four (4) SATA3 devices compatible with RAID 0, 1, 5, 10
		<ul style="list-style-type: none"> sSATA controller supports four (4) SATA3 devices compatible with RAID 0, 1, 10
	<ul style="list-style-type: none"> RAID configurations cannot cross the two (AHCI and sSATA) controllers 	
	SATA DOM	Two (2) SATA DOM Ports (SATA 4/5)
	USB Devices	
	Eight (8) USB 2.0 ports (2 rear, 6 via headers) Four (4) USB 3.0 headers for USB 3.0 support (2 rear, 1 Type-A, 1 via header)	
	Serial (COM) Ports	
	Two (2) COM Ports (1 header, 1 rear)	
Graphics Controller		
AST 2400 Graphics Controller		

BIOS	128 Mb AMI BIOS [®] SPI Flash BIOS
	Plug and Play (PnP), DMI 2.3, PCI 2.3, ACPI 1.0/2.0/3.0, USB Keyboard and SMBIOS 2.5
Power Configuration	ACPI/ACPM Power Management
	Main Switch Override Mechanism
	Keyboard Wake-up from Soft-Off
	Power-on mode for AC power recovery
PC Health Monitoring	CPU Monitoring
	Onboard voltage monitors for CPU core, +3.3V, +5V,+12V, +3.3V Stdby, VBAT, Memory, PCH and BMC voltage
	CPU 5-phase switching voltage
	CPU/System overheat LED and control
	CPU Thermal Trip support
	Thermal Monitor support
	Fan Control
	Fan status monitoring with firmware 4-pin fan speed control via IPMI interface
	Low noise fan speed control
	System Management
	UID (Unit Identification)/Remote UID
	System resource alert via SuperDoctor [®] 5
	SuperDoctor [®] 5, Watch Dog, NMI
	Chassis Intrusion header and detection
	BIOS flash upgrade utility
Dimensions	WIO form factor: 8" x 13" (203.2mm x 330.2mm)



Note: It is strongly recommended that you change BMC log-in information upon initial system power-on. The manufacture default username is ADMIN and the password is ADMIN. For proper BMC configuration, please refer to http://www.supermicro.com/products/info/files/IPMI/Best_Practices_BMC_Security.pdf.

X10SRW-F Block Diagram

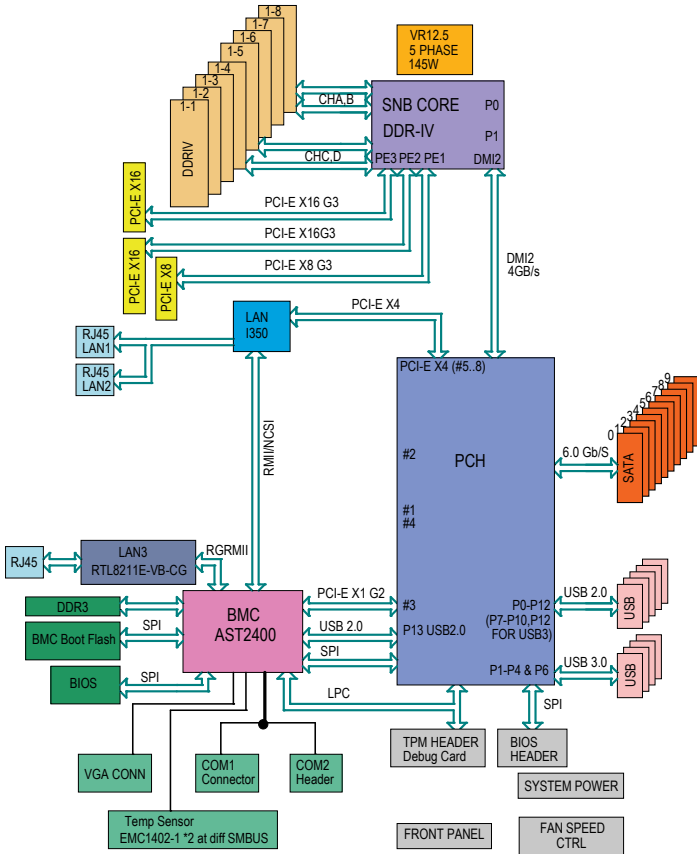

System Block Diagram

 **Note:** This is a general BMC block diagram and may not exactly represent the features on your motherboard. See the Motherboard Features pages for the actual specifications of each motherboard.

1-2 Chipset Overview

The X10SRW-F supports a single Intel[®] E5-2600/1600 Series Processor in an LGA2011 R3 socket. Built upon the functionality and the capability of the Intel[®] C612 Express chipset, the motherboard provides substantial enhancement to system performance and storage capability for high performance platforms in a sleek package.

The high-speed Direct Media Interface (DMI) featured in the Intel[®] C612 Express chipset supports high-speed Direct Media Interface (DMI) for chip-to-chip true isochronous communication, providing up to 5 GT/s of software-transparent data transfer rate on each read/write direction. In addition, the X10SRW-F also features a TCO timer which allows the system to recover from a software/hardware lock and perform tasks, including Function Disable and Intruder Detect.

Intel C612 Express Chipset Features

- Direct Media Interface (up to 5 GT/s transfer, Full Duplex)
- Dual NAND Interface
- Intel I/O Virtualization (VT-d) Support
- Intel Trusted Execution Technology Support
- PCI Express 2.0 Interface (up to 5.0 GT/s)
- SATA Controller (up to 6Gb/sec)
- Advanced Host Controller Interface (AHCI)



Note: Both E5-2600v4 and E5-1600v4 require Revision 2.0 BIOS (or higher).

1-3 Special Features

Recovery from AC Power Loss

Basic I/O System (BIOS) provides a setting for you to determine how the system will respond when AC power is lost and then restored to the system. You can choose for the system to remain powered off, (in which case you must press the power switch to turn it back on), or for it to automatically return to a power-on state. See the Advanced BIOS Setup section to change this setting. The default setting is **Last State**.

1-4 PC Health Monitoring

This section describes the PC health monitoring features of the board. All have an onboard System Hardware Monitoring chip that supports PC health monitoring. An onboard voltage monitor will scan these onboard voltages continuously: CPU Vcore, 12V, 5V, 5VSB, 3.3V, 3.3VSB, Memory, PCH, BMC and Battery voltages. Once a voltage becomes unstable, a warning is given, or an error message is sent to the screen. The user can adjust the voltage thresholds to define the sensitivity of the voltage monitor.

Environmental Temperature Control

The thermal control sensor monitors the CPU temperature in real time and will turn on the thermal control fan whenever the CPU temperature exceeds a user-defined threshold. The overheat circuitry runs independently from the CPU. Once the thermal sensor detects that the CPU temperature is too high, it will automatically turn on the thermal fans to prevent the CPU from overheating. The onboard chassis thermal circuitry can monitor the overall system temperature and alert the user when the chassis temperature is too high.



Note: To avoid possible system overheating, please be sure to provide adequate airflow to your system.

System Resource Alert

This feature is available when the system is used with SuperDoctor® 5 in the Windows OS environment or used with SuperDoctor II in Linux. SuperDoctor is used to notify the user of certain system events. For example, you can also configure SuperDoctor to provide you with warnings when the system temperature, CPU temperatures, voltages and fan speeds go beyond predefined thresholds.

1-5 ACPI Features

ACPI stands for Advanced Configuration and Power Interface. The ACPI specification defines a flexible and abstract hardware interface that provides a standard way to integrate power management features throughout a PC system, including its hardware, operating system and application software. This enables the system to automatically turn on and off peripherals such as CD-ROMs, network cards, hard disk drives and printers.

In addition to enabling operating system-directed power management, ACPI also provides a generic system event mechanism for Plug and Play, and an operating system-independent interface for configuration control. ACPI leverages the Plug and Play BIOS data structures, while providing a processor architecture-independent implementation that is compatible with Windows 7, Windows 8, and Windows 2008 Operating Systems.

Slow Blinking LED for Suspend-State Indicator

When the CPU goes into a suspend state, the chassis power LED will start to blink to indicate that the CPU is in suspend mode. When the user presses any key, the CPU will "wake up", and the LED will automatically stop blinking and remain on.

1-6 Power Supply

As with all computer products, a stable power source is necessary for proper and reliable operation. It is even more important for processors that have high CPU clock rates.

This motherboard accommodates 24-pin ATX power supplies. Although most power supplies generally meet the specifications required by the CPU, some are inadequate. In addition, the 12V 8-pin power connector located at JPWR1 is also required to ensure adequate power supply to the system.

Warning: To avoid damaging the power supply or motherboard, please use a power supply that contains a 24-pin and an 8-pin power connectors. Be sure to connect the 24-pin (J24) and the 8-pin (JPWR1) power connectors on the motherboard to the power supply. Failure in doing so will void the manufacturer warranty on your power supply and motherboard.

It is strongly recommended that you use a high quality power supply that meets ATX power supply Specification 2.02 or above. It must also be SSI compliant. (For more information, please refer to the web site at <http://www.ssiforum.org/>). Additionally, in areas where noisy power transmission is present, you may choose to install a line filter to shield the computer from noise. It is recommended that you also install a power surge protector to help avoid problems caused by power surges.

1-7 Super I/O

The Super I/O supports two high-speed, 16550 compatible serial communication ports (UARTs). Each UART includes a 16-byte send/receive FIFO, a programmable baud rate generator, complete modem control capability and a processor interrupt system. Both UARTs provide legacy speed with baud rate of up to 115.2 Kbps as well as an advanced speed with baud rates of 250 K, 500 K, or 1 Mb/s, which support higher speed modems.

The Super I/O provides functions that comply with ACPI (Advanced Configuration and Power Interface), which includes support of legacy and ACPI power management through an SMI or SCI function pin. It also features auto power management to reduce power consumption.

Notes

Chapter 2

Installation

2-1 Standardized Warning Statements

The following statements are industry-standard warnings, provided to warn the user of situations which have the potential for bodily injury. Should you have questions or experience difficulty, contact Supermicro's Technical Support department for assistance. Only certified technicians should attempt to install or configure components. Read this section in its entirety before installing or configuring components in the Supermicro chassis.

Battery Handling



Warning!

There is a danger of explosion if the battery is replaced incorrectly. Replace the battery only with the same or equivalent type recommended by the manufacturer. Dispose of used batteries according to the manufacturer's instructions

電池の取り扱い

電池交換が正しく行われなかった場合、破裂の危険性があります。交換する電池はメーカーが推奨する型、または同等のものを使用下さい。使用済電池は製造元の指示に従って処分して下さい。

警告

電池更換不當會有爆炸危險。請只使用同類電池或製造商推薦的功能相當的電池更換原有電池。請按製造商的說明處理廢舊電池。

警告

電池更換不當會有爆炸危險。請使用製造商建議之相同或功能相當的電池更換原有電池。請按照製造商的說明指示處理廢棄舊電池。

Warnung

Bei Einsetzen einer falschen Batterie besteht Explosionsgefahr. Ersetzen Sie die Batterie nur durch den gleichen oder vom Hersteller empfohlenen Batterietyp. Entsorgen Sie die benutzten Batterien nach den Anweisungen des Herstellers.

Attention

Danger d'explosion si la pile n'est pas remplacée correctement. Ne la remplacer que par une pile de type semblable ou équivalent, recommandée par le fabricant. Jeter les piles usagées conformément aux instructions du fabricant.

¡Advertencia!

Existe peligro de explosión si la batería se reemplaza de manera incorrecta. Reemplazar la batería exclusivamente con el mismo tipo o el equivalente recomendado por el fabricante. Desechar las baterías gastadas según las instrucciones del fabricante.

אזהרה!

קיימת סכנת פיצוץ של הסוללה במידה והוחלפה בדרך לא תקינה. יש להחליף את הסוללה בסוג התואם מחברת יצרן מומלצת.

סילוק הסוללות המושמשות יש לבצע לפי הוראות היצרן.

هناك خطر من انفجار في حالة استبدال البطارية بطريقة غير صحيحة فعليك استبدال البطارية فقط بنفس النوع أو ما يعادلها كما أوصت به الشركة المصنعة تخلص من البطاريات المستعملة وفقا لتعليمات الشركة الصانعة

경고!

배터리가 올바르게 교체되지 않으면 폭발의 위험이 있습니다. 기존 배터리와 동일하거나 제조사에서 권장하는 동등한 종류의 배터리로만 교체해야 합니다. 제조사의 안내에 따라 사용된 배터리를 처리하여 주십시오.

Waarschuwing

Er is ontploffingsgevaar indien de batterij verkeerd vervangen wordt. Vervang de batterij slechts met hetzelfde of een equivalent type die door de fabrikant aanbevolen wordt. Gebruikte batterijen dienen overeenkomstig fabrieksvorschriften afgevoerd te worden.

Product Disposal



Warning!

Ultimate disposal of this product should be handled according to all national laws and regulations.

製品の廃棄

この製品を廃棄処分する場合、国の関係する全ての法律・条例に従い処理する必要があります。

警告

本产品的废弃处理应根据所有国家的法律和规章进行。

警告

本產品的廢棄處理應根據所有國家的法律和規章進行。

Warnung

Die Entsorgung dieses Produkts sollte gemäß allen Bestimmungen und Gesetzen des Landes erfolgen.

¡Advertencia!

Al deshacerse por completo de este producto debe seguir todas las leyes y reglamentos nacionales.

Attention

La mise au rebut ou le recyclage de ce produit sont généralement soumis à des lois et/ou directives de respect de l'environnement. Renseignez-vous auprès de l'organisme compétent.

סילוק המוצר

אזהרה!

סילוק סופי של מוצר זה חייב להיות בהתאם להנחיות וחוקי המדינה.

عند التخلص النهائي من هذا المنتج ينبغي التعامل معه وفقا لجميع القوانين واللوائح الوطنية

경고!

이 제품은 해당 국가의 관련 법규 및 규정에 따라 폐기되어야 합니다.

Waarschuwing

De uiteindelijke verwijdering van dit product dient te geschieden in overeenstemming met alle nationale wetten en reglementen.

2-2 Static-Sensitive Devices

Electrostatic-Discharge (ESD) can damage electronic components. To avoid damaging your system board, it is important to handle it very carefully. The following measures are generally sufficient to protect your equipment from ESD.

Precautions

- Use a grounded wrist strap designed to prevent static discharge.
- Touch a grounded metal object before removing the board from the antistatic bag.
- Handle the board by its edges only; do not touch its components, peripheral chips, memory modules or gold contacts.
- When handling chips or modules, avoid touching their pins.
- Put the motherboard and peripherals back into their antistatic bags when not in use.
- For grounding purposes, make sure your computer chassis provides excellent conductivity between the power supply, the case, the mounting fasteners and the motherboard.
- Use only the correct type of onboard CMOS battery. Do not install the onboard battery upside down to avoid possible explosion.

Unpacking

The motherboard is shipped in antistatic packaging to avoid static damage. When unpacking the board, make sure that the person handling it is static protected.

2-3 Motherboard Installation

All motherboards have standard mounting holes to fit different types of chassis. Make sure that the locations of all the mounting holes for both motherboard and chassis match. Although a chassis may have both plastic and metal mounting fasteners, metal ones are highly recommended because they ground the motherboard to the chassis. Make sure that the metal standoffs click in or are screwed in tightly. Then use a screwdriver to secure the motherboard onto the motherboard tray.

Tools Needed



Phillips Screwdriver
(1)



Phillips Screws (7)



Standoffs (7)
Only if Needed

Location of Mounting Holes

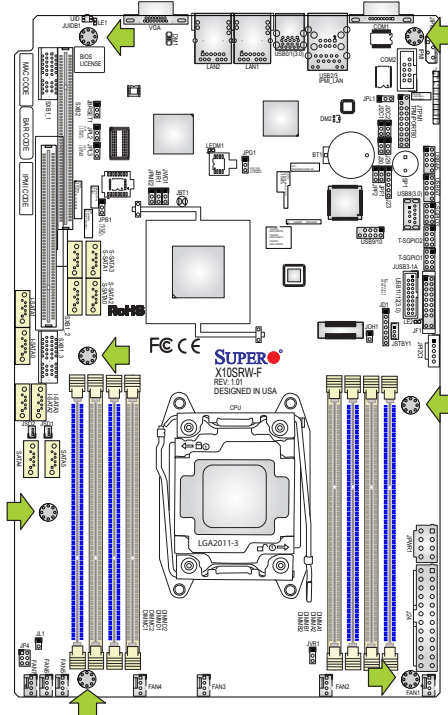

Caution: 1) To avoid damaging the motherboard and its components, please do not use a force greater than 8 lb/inch on each mounting screw during motherboard installation. 2) Some components are very close to the mounting holes. Please take precautionary measures to avoid damaging these components when installing the motherboard to the chassis.

Installing the Motherboard

1. Install the I/O shield into the back of the chassis.

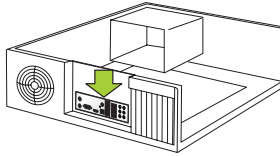

2. Locate the mounting holes on the motherboard. (See the previous page.)
3. Locate the matching mounting holes on the chassis. Align the mounting holes on the motherboard against the mounting holes on the chassis.
4. Install standoffs in the chassis as needed.

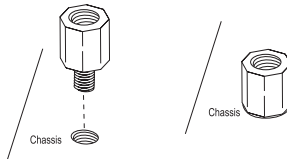

5. Install the motherboard into the chassis carefully to avoid damaging other motherboard components.
6. Using the Phillips screwdriver, insert a Phillips head #6 screw into a mounting hole on the motherboard and its matching mounting hole on the chassis.

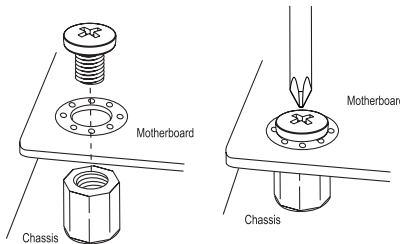

7. Repeat Step 5 to insert #6 screws into all mounting holes.
8. Make sure that the motherboard is securely placed in the chassis.

 **Note:** Images displayed are for illustration only. Your chassis or components might look different from those shown in this manual.

2-4 Processor and Heatsink Installation

Warning: When handling the processor package, avoid placing direct pressure on the label area of the fan.



Notes:

- Always connect the power cord last, and always remove it before adding, removing or changing any hardware components. Make sure that you install the processor into the CPU socket before you install the CPU heatsink.
- If you buy a CPU separately, make sure that you use an Intel-certified multi-directional heatsink only.
- Make sure to install the system board into the chassis before you install the CPU heatsink.
- When receiving a server board without a processor pre-installed, make sure that the plastic CPU socket cap is in place and none of the socket pins are bent; otherwise, contact your retailer immediately.
- Refer to the Supermicro website for updates on CPU support.

Installing the LGA2011 Processor

1. There are two load levers on the LGA2011 socket. To open the socket cover, first press and release the load lever labeled 'Open 1st'.

1

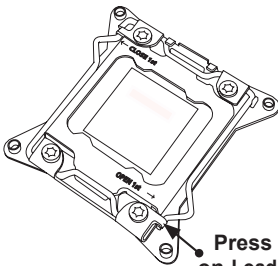

2

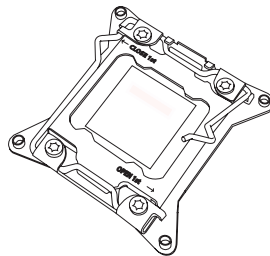

Press down
on Load Lever
labeled 'Open 1st'.

2. Press the second load lever labeled 'Close 1st' to release the load plate that covers the CPU socket from its locking position.

1

Press down on Load
Lever 'Close 1st'

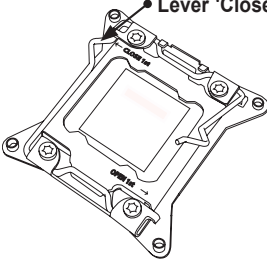

2 Pull lever away from
the socket

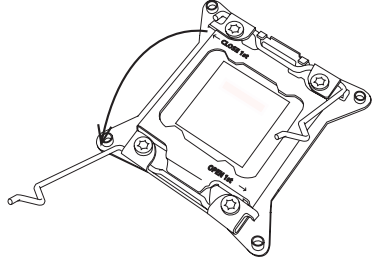

3. With the 'Close 1st' lever fully retracted, gently push down on the 'Open 1st' lever to open the load plate. Lift the load plate to open it completely.

1

Gently push
down to pop the
load plate open.

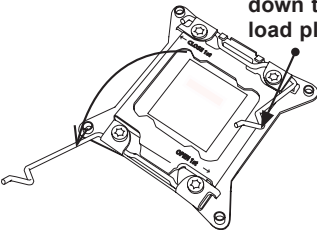

2

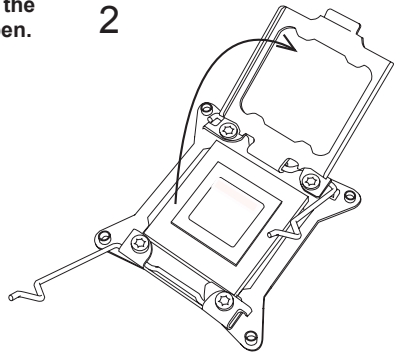

- Using your thumb and the index finger, loosen the CPU lever and open the load plate.

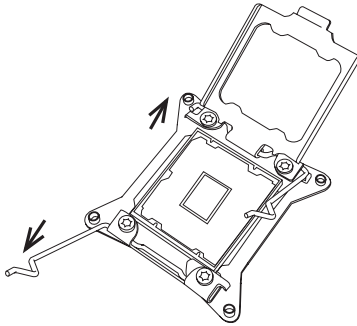

- Use your thumb and index finger to hold the CPU on its edges. Align the CPU keys, which are semi-circle cutouts, against the socket keys.

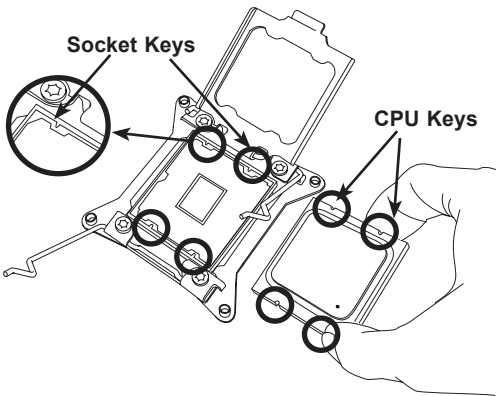

- Once they are aligned, carefully lower the CPU straight down into the socket. (Do not drop the CPU on the socket. Do not move the CPU horizontally or vertically. Do not rub the CPU against the surface or against any pins of the socket to avoid damaging the CPU or the socket.)

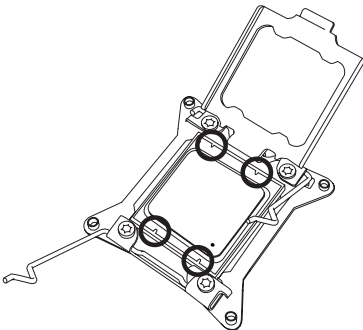

Warning: You can only install the CPU inside the socket in one direction. Make sure that it is properly inserted into the CPU socket before closing the load plate. If it doesn't close properly, do not force it as it may damage your CPU. Instead, open the load plate again and double-check that the CPU is aligned properly.

7. With the CPU inside the socket, inspect the four corners of the CPU to make sure that the CPU is properly installed.
8. Close the load plate with the CPU inside the socket. Lock the lever labelled 'Close 1st', then lock the lever labelled 'Open 1st' second. Using your thumb gently push the load levers down to the lever locks.

1 Gently close the load plate.

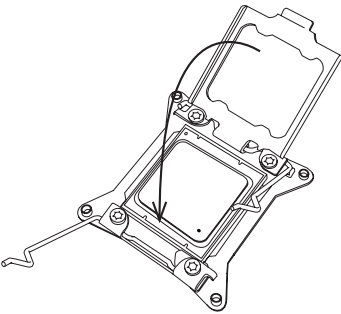

2 Push down and lock the lever labelled 'Close 1st'.

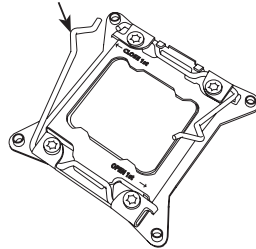

3 Push down and lock the lever labelled 'Open 1st'.

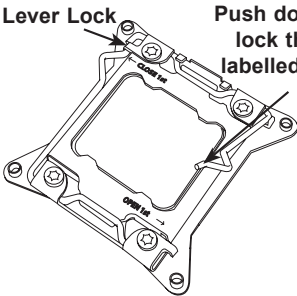

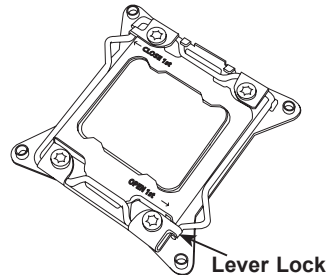

4

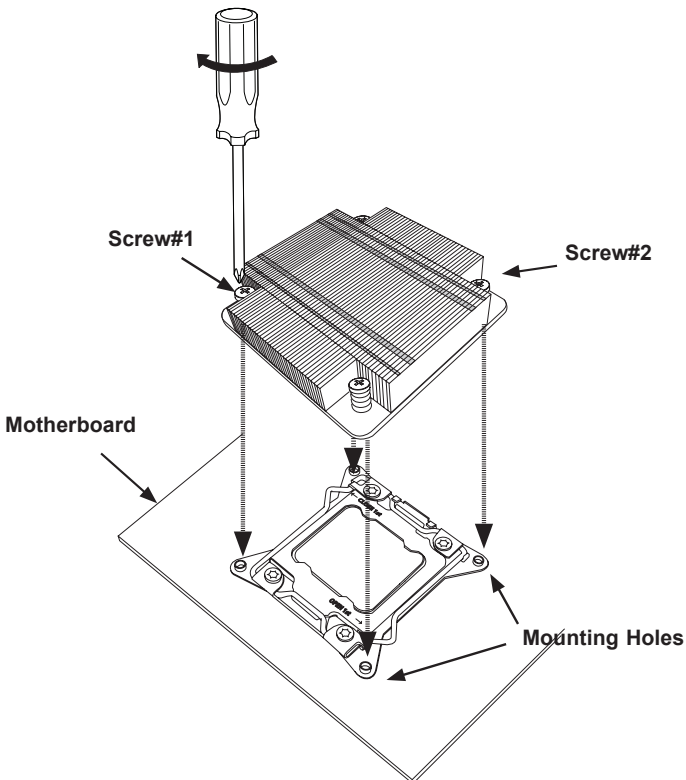

Installing a Passive CPU Heatsink

1. Do not apply any thermal grease to the heatsink or the CPU die -- the required amount has already been applied.
2. Place the heatsink on top of the CPU so that the four mounting holes are aligned with those on the motherboard's and the heatsink bracket underneath.
3. Screw in two diagonal screws (i.e., the #1 and the #2 screws) until just snug (-do not over-tighten the screws to avoid possible damage to the CPU.)
4. Finish the installation by fully tightening all four screws.



 **Note:** For optimized airflow, please follow your chassis airflow direction to install the correct CPU heatsink direction. Graphic drawings included in this manual are for reference only. They might look different from the components installed in your system

Removing the Heatsink

Warning: We do not recommend that the CPU or the heatsink be removed. However, if you do need to uninstall the heatsink, please follow the instructions below to prevent damage to the CPU or the CPU socket.

1. Unscrew the heatsink screws from the motherboard in the sequence as shown in the illustration below.
2. Gently wriggle the heatsink to loosen it from the CPU. (Do not use excessive force when wriggling the heatsink!)
3. Once the heatsink is loosened, remove the heatsink from the CPU socket.
4. Remove the used thermal grease and clean the surface of the CPU and the heatsink. Reapply the proper amount of thermal grease on the surface before reinstalling the heatsink.

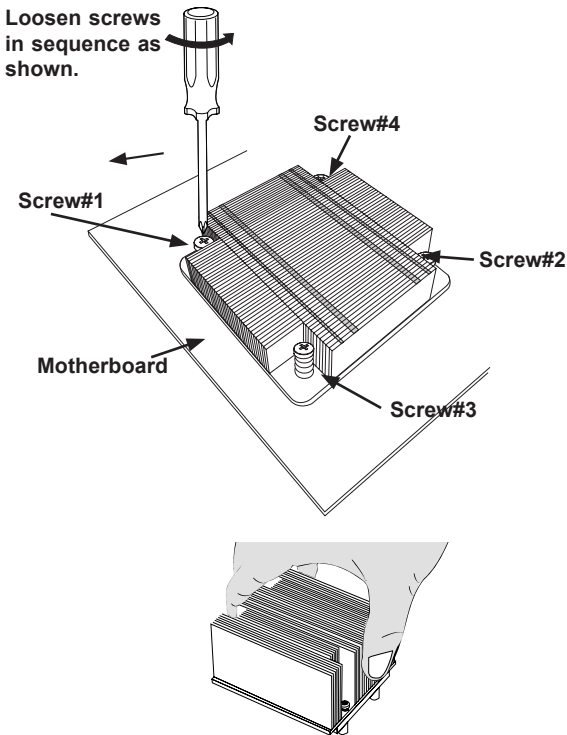

2-5 Installing DDR4 Memory

 **Note:** Check the Supermicro website for recommended memory modules.

CAUTION

Exercise extreme care when installing or removing DIMM modules to prevent any possible damage.

DIMM Installation

1. Insert the desired number of DIMMs into the memory slots, starting with DIMMA1 (Channel A, Slot 1, see the next page for the location). For the system to work properly, please use memory modules of the same type and speed.
2. Push the release tabs outwards on both ends of the DIMM slot to unlock it.
3. Align the key of the DIMM module with the receptive point on the memory slot.
4. Align the notches on both ends of the module against the receptive points on the ends of the slot.
5. Use two thumbs together to press the notches on both ends of the module straight down into the slot until the module snaps into place.
6. Press the release tabs to the lock positions to secure the DIMM module into the slot.

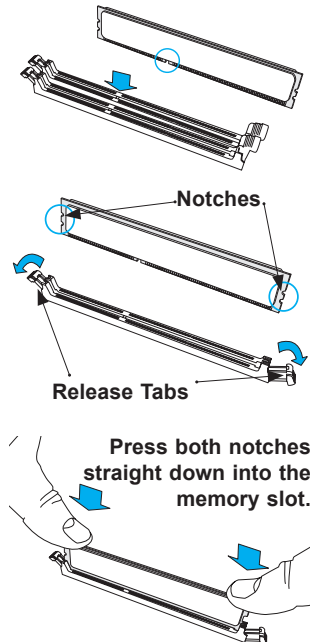
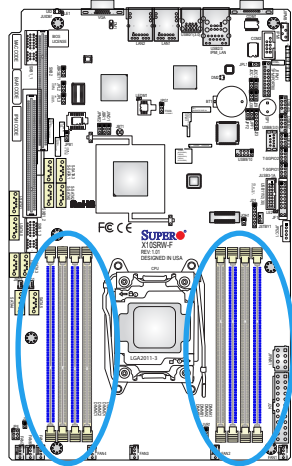

Removing Memory Modules

Reverse the steps above to remove the DIMM modules from the motherboard.

Memory Support

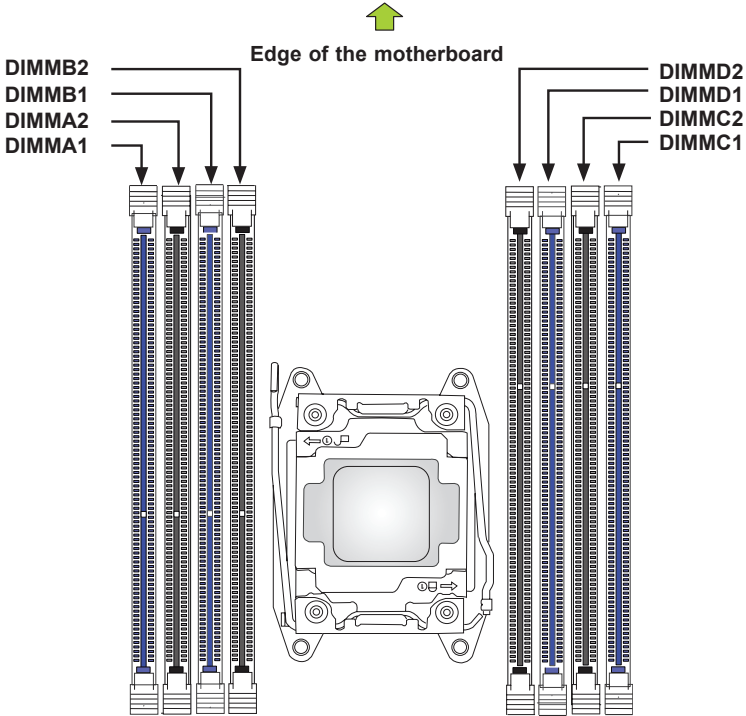

The X10SRW-F supports eight ECC DDR4 RDIMM/LRDIMM/UDIMM at 2400 MHz (max.) memory (1 DPC) up to 256GB RDIMM, 512GB LRDIMM, or 64GB UDIMM. Populating these DIMM modules with a pair of memory modules of the same type and same size will result in interleaved memory, which will improve memory performance. Please refer to the tables on the next page.

Memory Population Guidelines

Please follow the tables below when populating the X10SRW-F.

Populating RDIMM/LRDIMM DDR4 Memory Modules for the E5-2600v3-based Motherboard

Type	Ranks Per DIMM and Data Width	DIMM Capacity (GB)		Speed (MT/s); Voltage (V); Slot Per Channel (SPC) and DIMM Per Channel (DPC)		
				1 Slot Per Channel	2 Slots Per Channel	
		4Gb	8Gb	1DPC	1DPC	2DPC
RDIMM	SRx4	8GB	16GB	2133	2133	1866
RDIMM	SRx8	4GB	8GB	2133	2133	1866
RDIMM	DRx8	8GB	16GB	2133	2133	1866
RDIMM	DRx4	16GB	32GB	2133	2133	1866
LRDIMM	QRx4	32GB	64GB	2133	2133	2133
LRDIMM 3DS [†]	8Rx4	64GB	128GB	2133	2133	2133

Populating RDIMM/LRDIMM DDR4 Memory Modules for the E5-2600v4-based Motherboard

Type	Ranks Per DIMM and Data Width	DIMM Capacity (GB)		Speed (MT/s); Voltage (V); Slot Per Channel (SPC) and DIMM Per Channel (DPC)		
				1 Slot Per Channel	2 Slots Per Channel	
		4Gb	8Gb	1DPC	1DPC	2DPC
RDIMM	SRx4	8GB	16GB	2400	2400	2133
RDIMM	SRx8	4GB	8GB	2400	2400	2133
RDIMM	DRx8	8GB	16GB	2400	2400	2133
RDIMM	DRx4	16GB	32GB	2400	2400	2133
LRDIMM	QRx4	32GB	64GB	2400	2400	2400
LRDIMM 3DS	8Rx4	64GB	128GB	2400	2400	2400



Notes:

- Be sure to use memory modules of the same type and speed. Mixing of memory modules of different types and speeds is not allowed.
- Due to memory allocation to system devices, the amount of memory that remains available for operational use will be reduced when 4 GB of RAM is used. The reduction in memory availability is disproportional. See the following table for details.

Possible System Memory Allocation & Availability		
System Device	Size	Physical Memory Remaining (-Available) (4 GB Total System Memory)
Firmware Hub flash memory (System BIOS)	1 MB	3.99
Local APIC	4 KB	3.99
Area Reserved for the chipset	2 MB	3.99
I/O APIC (4 Kbytes)	4 KB	3.99
PCI Enumeration Area 1	256 MB	3.76
PCI Express (256 MB)	256 MB	3.51
PCI Enumeration Area 2 (if needed) -Aligned on 256-MB boundary-	512 MB	3.01
VGA Memory	16 MB	2.85
TSEG	1 MB	2.84
Memory available to OS and other applications		2.84

2-6 Connectors/I/O Ports

The I/O ports are color coded in accordance with the industry standards. See the figure below for the colors and locations of the various I/O ports.

I/O Back Panel

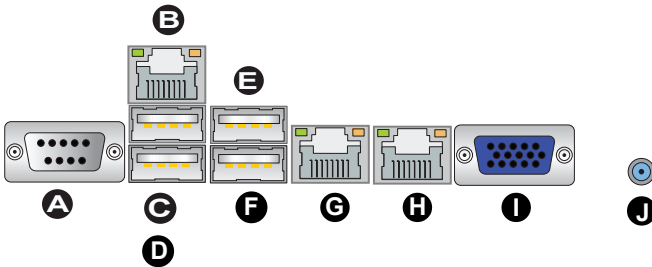
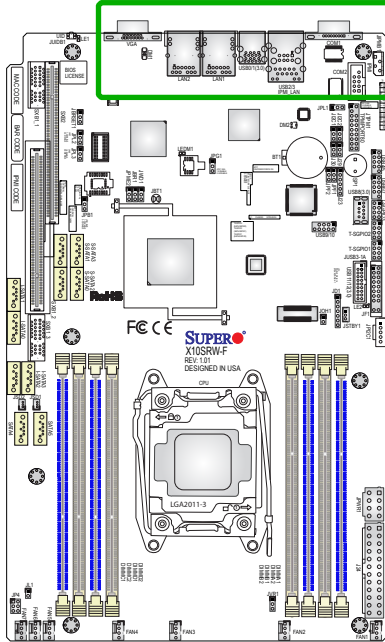

I/O Back Panel	
A. COM1	F. USB Port 4 (3.0)
B. IPMI LAN	G. LAN1
C. USB Port 0 (2.0)	H. LAN2
D. USB Port 1 (2.0)	I. VGA Port
E. USB Port 3 (3.0)	J. UID Switch

Universal Serial Bus (USB)

Four Universal Serial Bus ports (USB 3.0 ports 0/1 and USB 2.0 ports 2/3) are located on the I/O back panel. In addition, three USB 2.0 headers (USB 4/5, 6/7, 9/10), and two USB 3.0 headers (USB 8 (Type A), USB 11/12) are also located on the motherboard to provide USB 3.0 support using USB cables (not included). See the table on the right for pin definitions.

Front Panel USB (2.0) 2/3 Pin Definitions			
Pin #	Definition	Pin #	Definition
1	+5V	2	+5V
3	USB_PN2	4	USB_PN3
5	USB_PP2	6	USB_PP3
7	Ground	8	Ground
9	Key	10	Ground

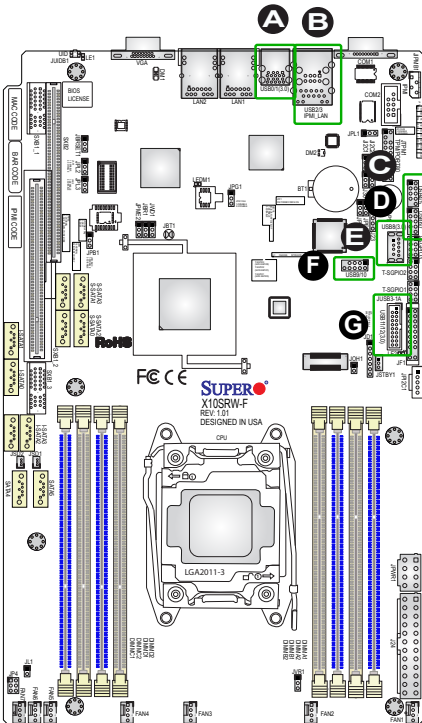

- A. Back Panel USB 3.0 #0/1
- B. Back Panel USB 2.0 #2/3
- C. Front Panel USB 2.0 #4/5
- D. Front Panel USB 2.0 #6/7
- E. Front Panel USB 3.0 #8 (Type A)
- F. Front Panel USB 2.0 #9/10
- G. Front Panel USB 3.0 #11/12

Ethernet Ports

Two Gigabit Ethernet ports (LAN1/LAN2) and an IPMI LAN port are located on the I/O back panel to provide network connections. These ports accept RJ45 type cables.

 **Note:** Please refer to the LED Indicator Section for LAN LED information.

LAN Ports Pin Definition			
Pin#	Definition		
1	SGND	9	TD0+
2	TD0+	10	TD0-
3	TD3+	11	Link 1000 LED (Green, +3V3SB)
4	TD3-	12	Link 1000 LED (Yellow, +3V3SB)
5	TD2+	13	Act LED
6	TD2-	14	
7	TD1+	15	SGND
8	TD1-	16	SGND

(NC: No Connection)

Serial Ports (COM1/COM2)

Serial port COM1 is located next to USB 0/1 on the I/O back panel. Another Serial port header (COM2) is located next to IPMI_LAN on the motherboard. See the table on the right for pin definitions.

Serial Ports Pin Definitions			
Pin #	Definition	Pin #	Definition
1	DCD	6	DSR
2	RXD	7	RTS
3	TXD	8	CTS
4	DTR	9	RI
5	SGND	10	SGND

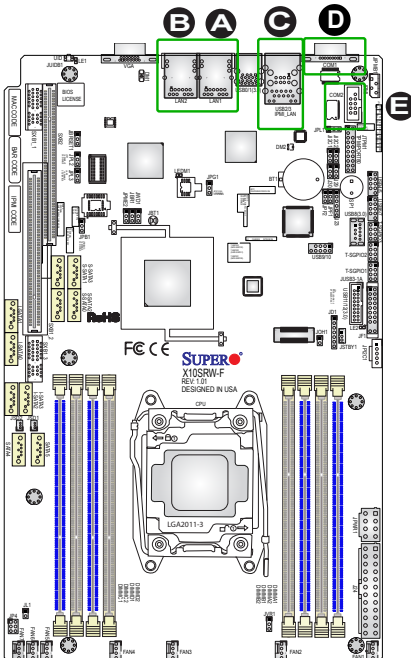

- A. LAN1
- B. LAN2
- C. IPMI LAN
- D. COM1
- E. COM2

Unit Identifier Switch/UID LED Indicator

A Unit Identifier (UID) switch and an LED Indicator are located on the motherboard. The UID switch is located next to the VGA port on the back panel. The UID LED (LaE1) is located next to the UID switch. When you press the UID switch, the UID LED will be turned on. Press the UID switch again to turn off the LED indicator. The UID Indicator provides easy identification of a system unit that may be in need of service.

Note: UID can also be triggered via IPMI on the motherboard. For more information on IPMI, please refer to the IPMI User's Guide posted on our website: <http://www.supermicro.com/support/manuals/>

UID Switch	
Pin#	Definition
1	Ground
2	Ground
3	Button In
4	Button In

UID LED Status	
Color/State	Status
Blue: On	Unit Identified

VGA Port

The onboard VGA port is located next to LAN Ports 1/2 on the I/O back panel. Use the connection for VGA display.

- A. VGA
- B. UID Switch
- C. UID LED

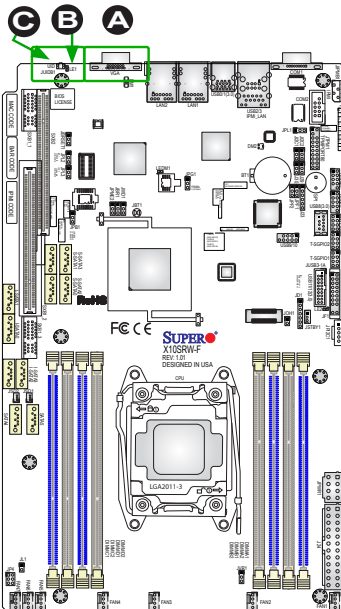

Front Control Panel

JF1 contains header pins for various buttons and indicators that are normally located on a control panel at the front of the chassis. These connectors are designed specifically for use with Supermicro chassis. See the figure below for the descriptions of the front control panel buttons and LED indicators. Refer to the following section for descriptions and pin definitions.

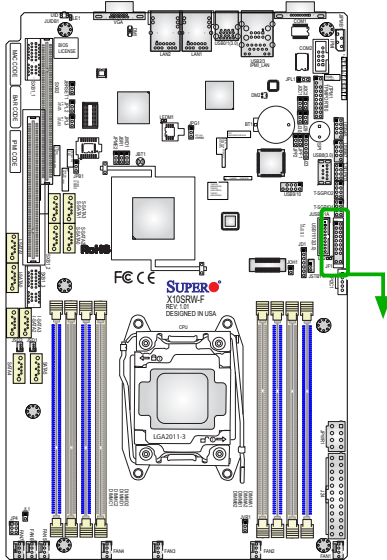

JF1 Header Pins

	20	19	
Ground	○	○	NMI
X	○	○	X
Power LED	○	○	P3V3
HDD LED	○	○	UID SW
NIC1 LED	○	○	P3V3_STB
NIC2 LED	○	○	P3V3_STB
OH/Fan Fail LED	○	○	UID LED
PWR Fail LED	○	○	P3V3
Ground	○	○	Reset } Reset Button
Ground	○	○	PWR } Power Button
	2	1	

Front Control Panel Pin Definitions

NMI Button

The non-maskable interrupt button header is located on pins 19 and 20 of JF1. Refer to the table on the right for pin definitions.

NMI Button Pin Definitions (JF1)	
Pin#	Definition
19	Control
20	Ground

Power LED

The Power LED connection is located on pins 15 and 16 of JF1. Refer to the table on the right for pin definitions.

Power LED Pin Definitions (JF1)	
Pin#	Definition
15	3.3V
16	PWR LED

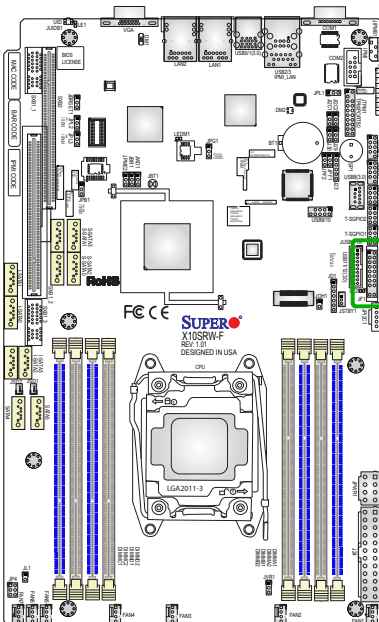

A. NMI

B. PWR LED

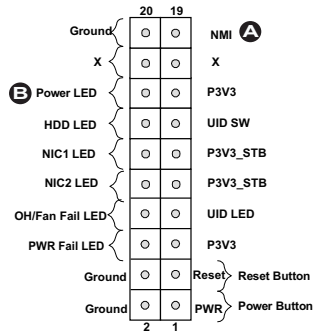

HDD LED

The HDD LED connection is located on pins 13 and 14 of JF1. Attach a cable here to indicate HDD activity. See the table on the right for pin definitions.

HDD LED Pin Definitions (JF1)	
Pin#	Definition
13	P3V3_STB
14	HD Active

NIC1/NIC2 LEDs

The NIC (Network Interface Controller) LED connection for GLAN Port 1 is located on pins 11 and 12 of JF1, and the LED connection for GLAN Port 2 is on pins 9 and 10. Attach the NIC LED cables to the LED indicators mentioned above to display network activity. Refer to the layout below for the locations of NIC LED indicators.

GLAN1/2 LED Pin Definitions (JF1)	
Pin#	Definition
9	P3V3_STB
10	NIC 2 Link/Activity LED
11	P3V3_STB
12	NIC 1 Link/Activity LED

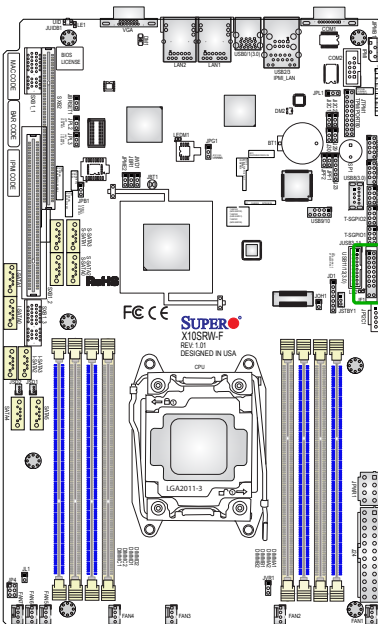

- A. HDD LED
- B. NIC1 LED
- C. NIC2 LED

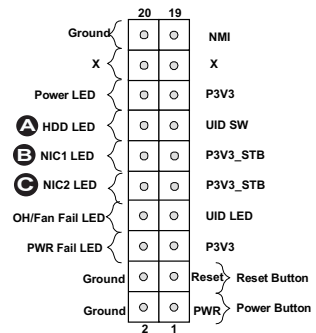

Overheat (OH)/Fan Fail/PWR Fail/UID LED

Connect an LED cable to pins 7 and 8 of Front Control Panel to use the Overheat, Fan Fail, and Power Fail connections. Refer to the table on the right for pin definitions.

OH/Fan Fail/ PWR Fail/Blue_UID LED Pin Definitions (JF1)	
Pin#	Definition
7	P5V_STB
8	Red_LED-Cathode/OH/Fan Fail/Power Fail

OH/Fan Fail/PWR Fail LED Status (Red LED)	
State	Definition
Off	Normal
On	Overheat
Flashing 1 Hz	Fan Fail
Flashing 1/4 Hz	Redundant Power Supply Fail

Power Fail LED

The Power Fail LED connection is located on pins 5 and 6 of JF1. Refer to the table on the right for pin definitions.

PWR Fail LED Pin Definitions (JF1)	
Pin#	Definition
5	3.3V
6	PWR LED Status

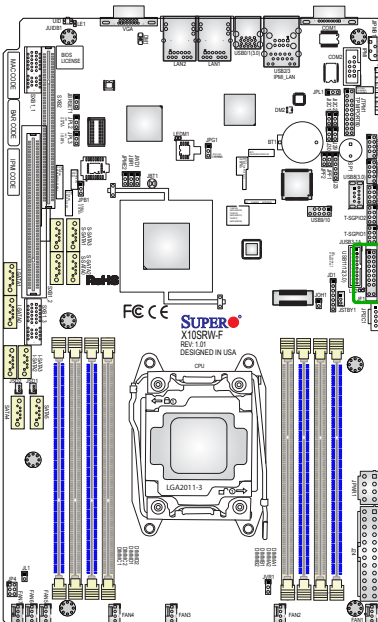

A. OH/Fan Fail/PWR Fail/UID LED
B. PWR Fail LED

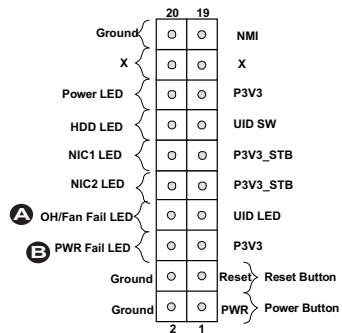

Reset Button

The Reset Button connection is located on pins 3 and 4 of JF1. Attach it to a hardware reset switch on the computer case. Refer to the table on the right for pin definitions.

Reset Button Pin Definitions (JF1)	
Pin#	Definition
3	Reset
4	Ground

Power Button

The Power Button connection is located on pins 1 and 2 of JF1. Momentarily contacting both pins will power on/off the system. This button can also be configured to function as a suspend button (with a setting in the BIOS - See Chapter 4). To turn off the power when the system is in suspend mode, press the button for 4 seconds or longer. Refer to the table on the right for pin definitions.

Power Button Pin Definitions (JF1)	
Pin#	Definition
1	Signal
2	Ground

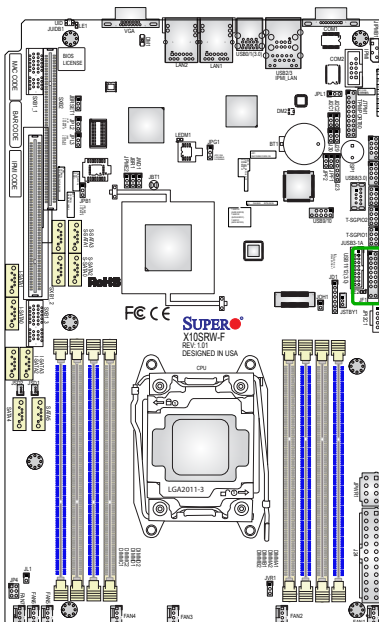

A. Reset Button

B. PWR Button

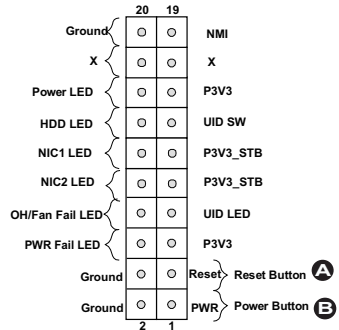

2-7 Connecting Cables

This section provides brief descriptions and pin-out definitions for onboard headers and connectors. Be sure to use the correct cable for each header or connector. For information on back panel USB and front panel USB ports, refer to page 2-17.

ATX Main PWR & CPU PWR Connectors (J24 & JPWR1)

The 24-pin main power connector (J24) is used to provide power to the motherboard. The 8-pin CPU PWR connector (JPWR1) is also required for the processor. These power connectors meet the SSI EPS 12V specification. See the table on the right for pin definitions.

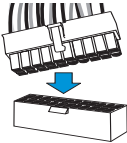

24-Pin Main PWR

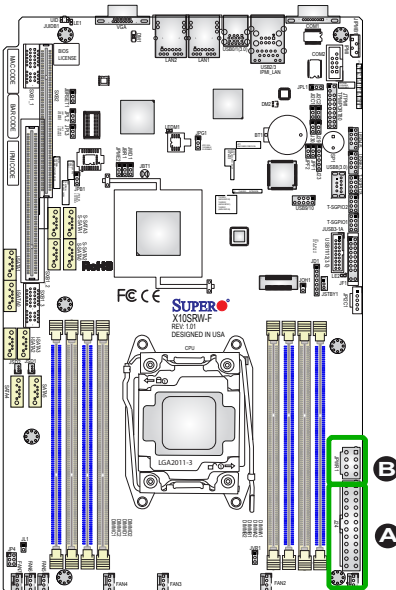

ATX Power 24-pin Connector Pin Definitions (JPW1)			
Pin#	Definition	Pin #	Definition
13	+3.3V	1	+3.3V
14	-12V	2	+3.3V
15	GND	3	GND
16	PS_ON	4	+5V
17	GND	5	GND
18	GND	6	+5V
19	GND	7	GND
20	Res (NC)	8	PWR_OK
21	+5V	9	5VSB
22	+5V	10	+12V
23	+5V	11	+12V
24	GND	12	+3.3V

12V 8-pin Power Connector Pin Definitions	
Pins	Definition
1 through 4	Ground
5 through 8	+12V

(Required)

A. 24-Pin ATX Main PWR

B. 8-Pin PWR

Fan Headers (Fan 1-2, Fan 4-7)

The X10SRW-F has six fan headers (Fan 1-2, Fan 4-7). These fans are 4-pin fan headers. Although pins 1-3 of the onboard fan headers are backward compatible with the traditional 3-pin fans, we recommend that you use 4-pin fans to take advantage of the fan speed control via IPMI interface. This allows the fan speeds to be automatically adjusted based on the motherboard temperature. Refer to the table on the right for pin definitions.

Fan Header Pin Definitions	
Pin#	Definition
1	Ground (Black)
2	2.5A/+12V (Red)
3	Tachometer
4	PWM_Control

Chassis Intrusion (JL1)

A Chassis Intrusion header is located at JL1 on the motherboard. Attach the appropriate cable from the chassis to inform you of a chassis intrusion when the chassis is opened.

Chassis Intrusion Pin Definitions (JL1)	
Pin#	Definition
1	Intrusion Input
2	Ground

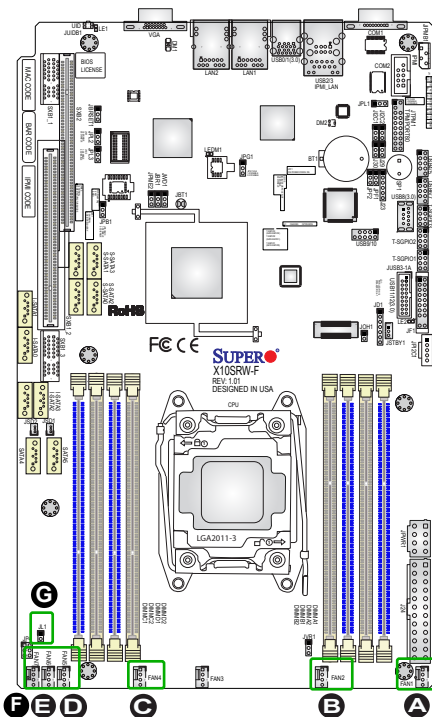

- A. Fan 1
- B. Fan 2
- C. Fan 4
- D. Fan 5
- E. Fan 6
- F. Fan 7
- G. Chassis Intrusion

Internal Speaker/Buzzer (SP1)

The Internal Speaker/Buzzer (SP1) is used to provide audible indications for various beep codes. See the table on the right for pin definitions.

Internal Buzzer Pin Definition		
Pin#	Definitions	
Pin 1	Pos. (+)	Beep In
Pin 2	Neg. (-)	Alarm Speaker

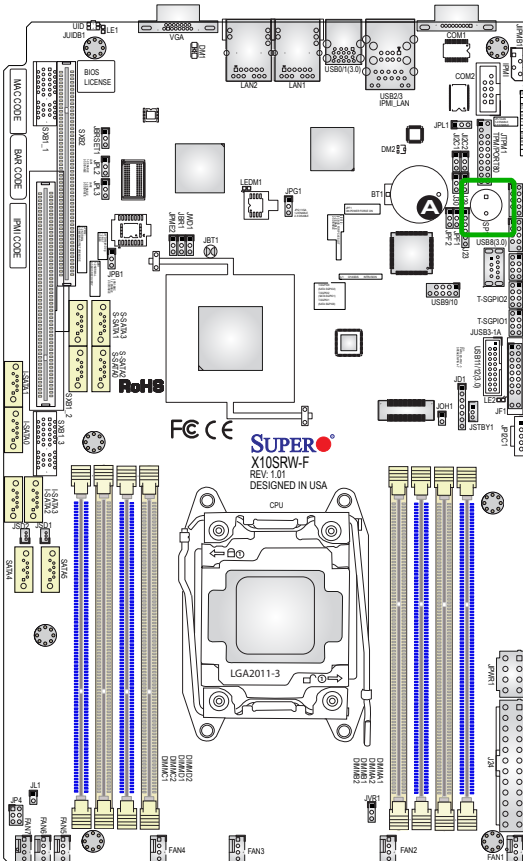

A. Internal Buzzer

DOM PWR Connectors (JSD1 & JSD2)

The Disk-On-Module (DOM) power connectors, located at JSD1 and JSD2, provide 5V power to a solid state DOM storage device connected to one of the SATA ports. See the table on the right for pin definitions.

DOM PWR Pin Definitions	
Pin#	Definition
1	5V
2	Ground
3	Ground

Standby Power

The Standby Power header is located at JSTBY1 on the motherboard. See the layout below for the location.

Standby Power Pin Definitions	
Pin#	Definition
1	+5V Standby
2	Ground
3	No Connection

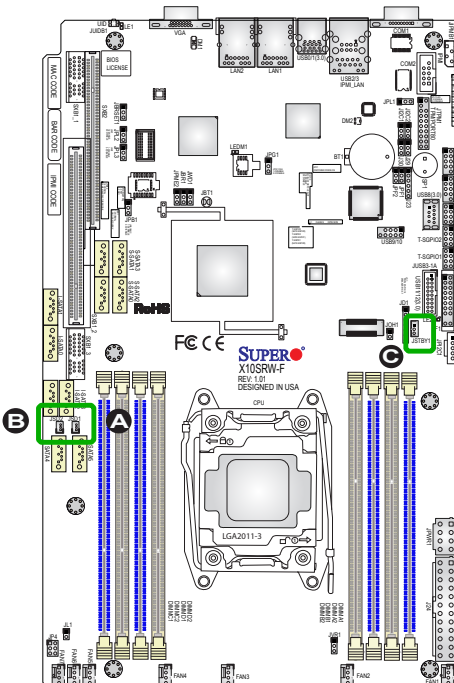

- A. DOM PWR 1
- B. DOM PWR 2
- C. Standby PWR

T-SGPIO 1/2/3 Headers

Three Serial-Link General Purpose Input/Output headers (T-SGPIO 1/2/3) are located on the motherboard. These T-SGPIO headers support onboard SATA interface. T-SGPIO1 is for I-SATA 0-3, T-SGPIO2 is for I-SATA 4-5, and T-SGPIO3 is for S-SATA 0-3. See the table on the right for pin definitions.

T-SGPIO Header Pin Definitions			
Pin#	Definition	Pin#	Definition
2	NC	1	NC
4	Data	3	Ground
6	Ground	5	Load
8	NC	7	Clock

Note: NC= No Connection

Power SMB (I²C) Connector

Power System Management Bus (I²C) Connector (JP1²C1) monitors power supply, fan and system temperatures. See the table on the right for pin definitions.

PWR SMB Pin Definitions	
Pin#	Definition
1	Clock
2	Data
3	PWR Fail
4	Ground
5	+3.3V

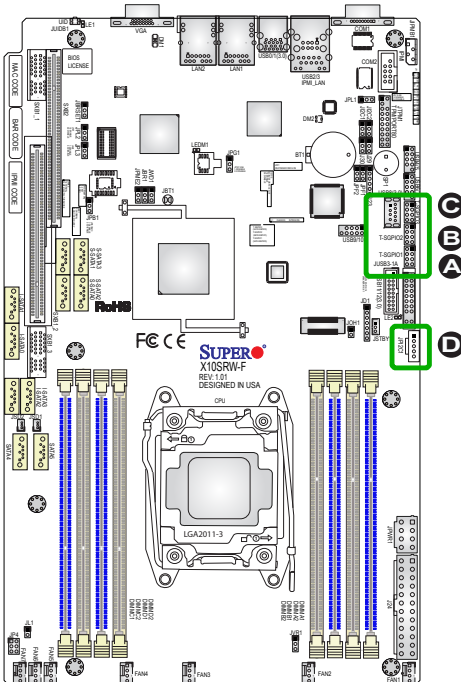

- A. T-SGPIO 1
- B. T-SGPIO 2
- C. T-SGPIO 3
- D. SMB Connector

TPM Header/Port 80 Header

A Trusted Platform Module/Port 80 header is located at JTPM1 to provide TPM support and Port 80 connection. Use this header to enhance system performance and data security. See the table on the right for pin definitions.

TPM/Port 80 Header Pin Definitions			
Pin #	Definition	Pin #	Definition
1	LCLK	2	GND
3	LFRAME#	4	<(KEY)>
5	LRESET#	6	+5V (X)
7	LAD 3	8	LAD 2
9	+3.3V	10	LAD1
11	LAD0	12	GND
13	SMB_CLK4	14	SMB_DAT
15	+3V_STB	16	SERIRQ
17	GND	18	CLKRUN#
19	LPCPD#	20	LDRQ# (X)

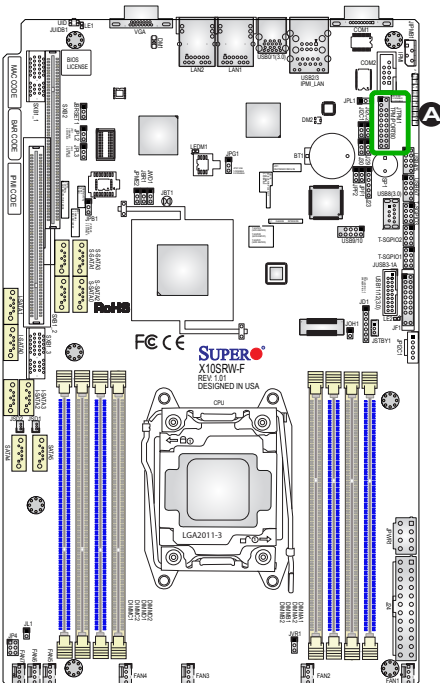

A. TPM/Port 80

2-8 Jumper Settings

Explanation of Jumpers

To modify the operation of the motherboard, jumpers can be used to choose between optional settings. Jumpers create shorts between two pins to change the function of the connector. Pin 1 is identified with a square solder pad on the printed circuit board.

Note: On two-pin jumpers, "Closed" means the jumper is on, and "Open" means the jumper is off the pins.

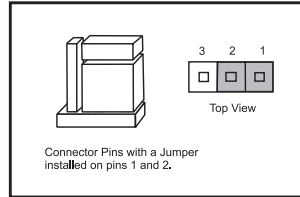
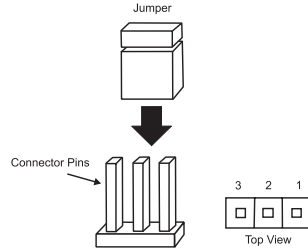

LAN1/LAN2 Enable/Disable

Jumpers JPL1/JPL2 enable or disable LAN ports 1/2 on the motherboard. See the table on the right for jumper settings. The default setting is enabled.

GLAN Enable Jumper Settings	
Pin#	Definition
1-2	Enabled (default)
2-3	Disabled

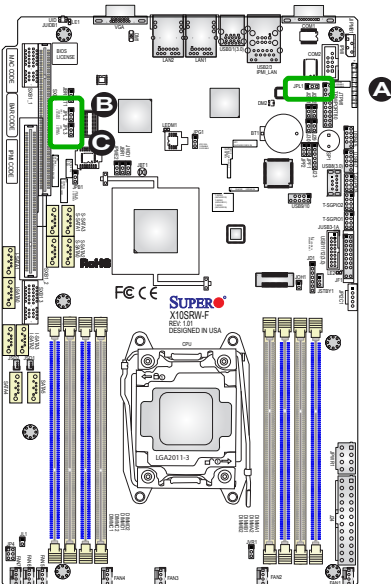

- A. JPL1: LAN Enable
- B. JPL2: LAN1 Enable
- C. JPL3: LAN2 Enable

CMOS Clear (JBT1)

JBT1 is used to clear the saved system setup configuration stored in the CMOS chip. To clear the contents of the CMOS, completely shut down the system, remove the AC power cord and then short JBT1 with a jumper. Remove the jumper before powering on the system again. This will erase all user settings and revert everything to their factory-set defaults.

PCI-E Slot SMB Enable (I²C1/I²C2)

Use Jumpers I²C1/I²C2 to enable PCI-E SMB (System Management Bus) support to improve system management for the PCI-E slots. See the table on the right for jumper settings.

PCI-E Slot_SMB Enable Jumper Settings	
Jumper Setting	Definition
1-2	Enabled
2-3	Disabled (Default)

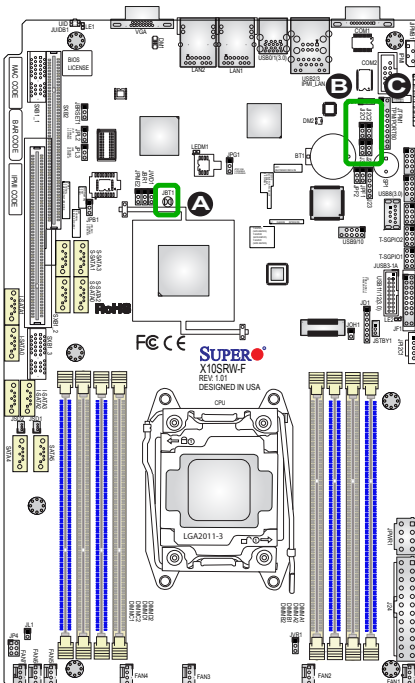

A. Clear CMOS

B. JI²C1

C. JI²C2

VGA Enable

Jumpers JPG1 allows the user to enable the onboard VGA connector. The default setting is 1-2 to enable the connection. See the table on the right for jumper settings.

VGA Enable Jumper Settings	
Jumper Setting	Definition
1-2	Enabled (Default)
2-3	Disabled

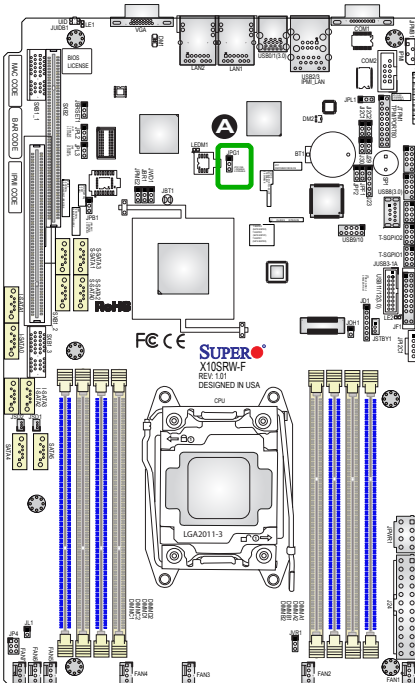

A. VGA Enable

Watch Dog Enable/Disable

Watch Dog (JWD1) is a system monitor that can reboot the system when a software application hangs. Close pins 1-2 to reset the system if an application hangs. Close pins 2-3 to generate a non-maskable interrupt signal for the application that hangs. See the table on the right for jumper settings. Watch Dog must also be enabled in the BIOS.

Watch Dog Jumper Settings	
Jumper Setting	Definition
Pins 1-2	Reset (default)
Pins 2-3	NMI
Open	Disabled

A. Watch Dog Enable

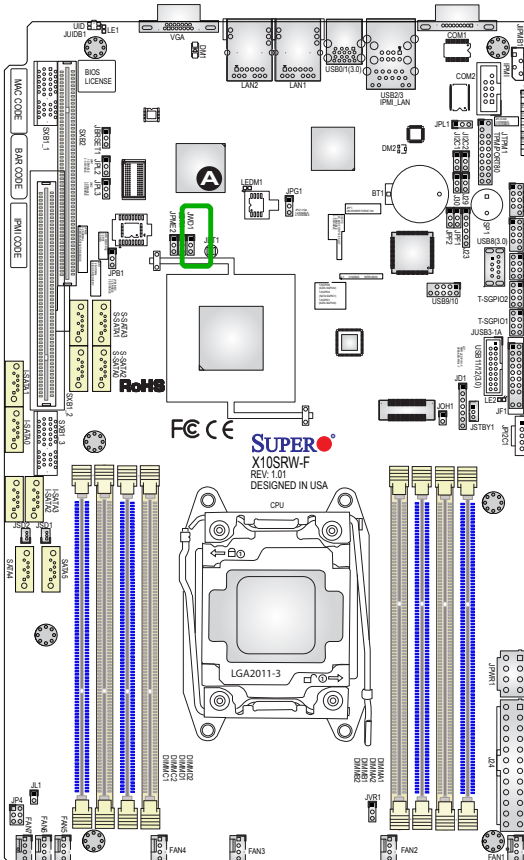

2-9 Onboard Indicators

LAN 1/LAN 2 LEDs

Two LAN ports (LAN 1/LAN 2) are located on the I/O back panel of the motherboard. Each Ethernet LAN port has two LEDs. The yellow LED indicates activity, while the Link LED may be green, amber, or off to indicate the speed of the connections. See the tables on the right for more information.

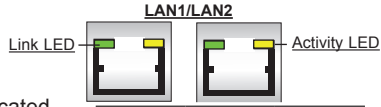

GLAN 1/2 Activity Indicator LED Settings		
Color	Status	Definition
Yellow	Flashing	Active

GLAN Ports 1/2 Link Indicator LED Settings	
LED Color	Definition
Off	No Connection/10 Mbps/
Green	100 Mbps
Amber	1 Gbps

Dedicated IPMI LAN LEDs

In addition to the Gigabit Ethernet ports, a dedicated IPMI LAN is also located above USB ports 0/1 on the I/O back panel. The yellow LED on the right indicates activity, while the green/amber LED on the left indicates the speed of the connection. See the table on the right for more information.

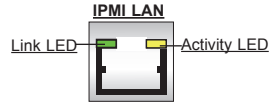

IPMI LAN Link LED (Left) & Activity LED (Right)		
	Color/State	Definition
Link (Left)	Amber: Solid	1 Gbps
	Green: Solid	100 Mbps
Activity (Right)	Yellow: Blinking	Active

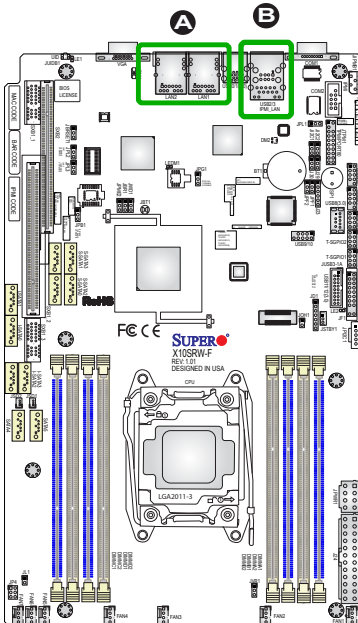

A. LAN 1/2 LEDs

B. IPMI LAN LED

BMC Heartbeat LED (LEDM1)

A BMC Heartbeat LED is located at LEDM1 on the X10SRW-F. See the table on the right for more information.

BMC Heartbeat LED Status	
Color/State	Definition
Green: Blinking	BMC: Normal

Unit Identification LED (LE1)

A rear UID LED indicator (LE1) is located next to the I/O back panel. This UID Indicator provides easy identification of a system unit that may be in need of service.

UID LED Status		
Color/State	OS	Status
Blue: On	Windows OS	Unit Identified

 **Note:** UID can also be triggered via IPMI on the motherboard. For more information on IPMI, please refer to the IPMI User's Guide posted on our website: <http://www.supermicro.com/support/manuals/>

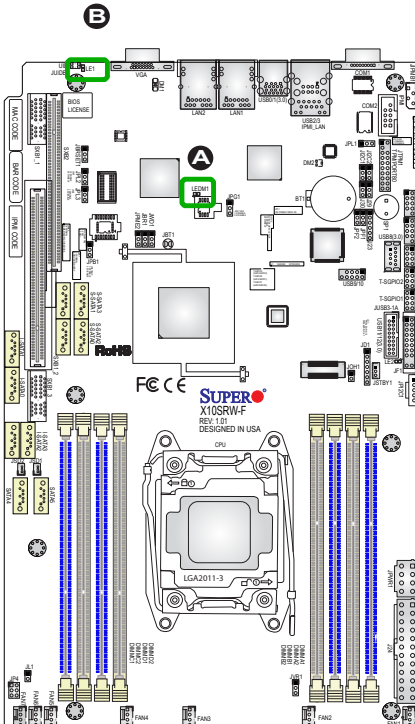

A. BMC Heartbeat LED

B. UID LED

Onboard Power LED (LE2)

An Onboard Power LED is located at LE2 on the motherboard. When LE2 is on, the AC power cable is connected. Make sure to disconnect the power cable before removing or installing any component. See the layout below for the LED location.

Onboard PWR LED Indicator LED Status	
Color/Status	Definition
Off	System Off
Green: On	System on

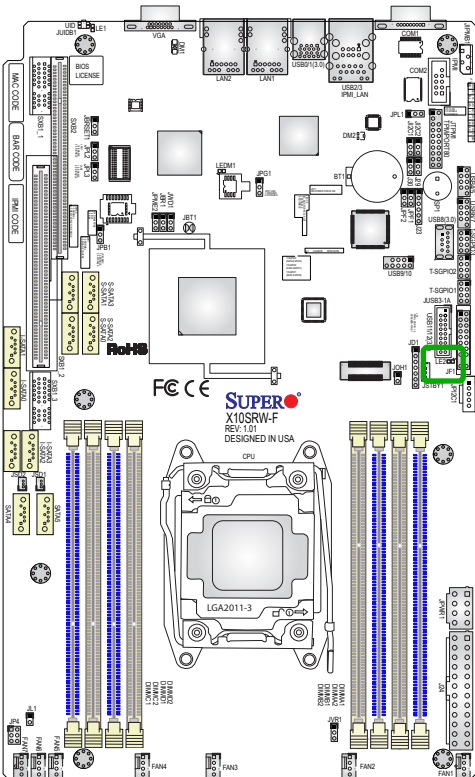

A. Onboard Power LED

2-10 SATA Connections

SATA Connections

Ten SATA 3.0 connectors (I-SATA 0-5) and (S-SATA 0-3) are located on the board. I-SATA 0-5 are supported by the AHCI controller and are compatible with RAID 0, 1, 5, 10. S-SATA 0-3 are supported by the sSATA controller and are compatible with RAID 0, 1, 10. These Serial Link connections provide faster data transmission than legacy Parallel ATA. See the table on the right for pin definitions.

SATA Connectors Pin Definitions	
Pin#	Signal
1	Ground
2	SATA_TXP
3	SATA_TXN
4	Ground
5	SATA_RXN
6	SATA_RXP
7	Ground

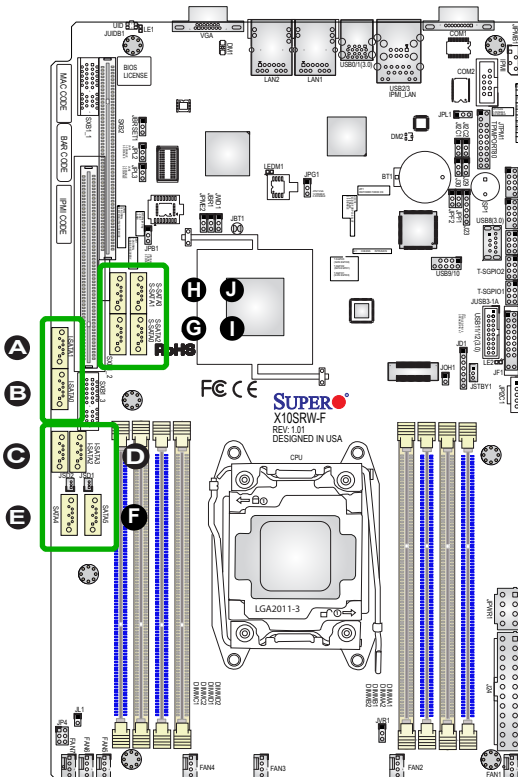

- A. I-SATA 0
- B. I-SATA 1
- C. I-SATA 2
- D. I-SATA 3
- E. I-SATA 4
- F. I-SATA 5
- G. S-SATA 0
- H. S-SATA 1
- I. S-SATA 2
- J. S-SATA 3

Notes

Chapter 3

Troubleshooting

3-1 Troubleshooting Procedures

Use the following procedures to troubleshoot your system. If you have followed all of the procedures below and still need assistance, refer to the 'Technical Support Procedures' and/or 'Returning Merchandise for Service' section(s) in this chapter. Always disconnect the AC power cord before adding, changing or installing any hardware components.

Before Power On

1. Make sure that the Standby PWR LED is not on. (**Note:** If it is on, the onboard power is on. Be sure to unplug the power cable before installing or removing the components.)
2. Make sure that there are no short circuits between the motherboard and chassis.
3. Disconnect all ribbon/wire cables from the motherboard, including those for the keyboard and mouse. Also, be sure to remove all add-on cards.
4. Install a CPU and heatsink (be sure that it is fully seated) and then connect the chassis speaker and the power LED to the motherboard. Check all jumper settings as well.

No Power

1. Make sure that there are no short circuits between the motherboard and chassis.
2. Make sure that all jumpers are set to their default positions.
3. Check if the 115V/230V switch on the power supply is properly set.
4. Turn the power switch on and off to test the system.
5. The battery on your motherboard may be old. Check to make sure that it still supplies ~3VDC. If it does not, replace it with a new one.

No Video

1. If the power is on, but you have no video--in this case, you will need to remove all the add-on cards and cables first.
2. Use the speaker to determine if any beep codes exist. (Refer to Appendix A for details on beep codes.)
3. Remove all memory modules and turn on the system. (If the alarm is on, check the specifications of memory modules, reset the memory or try a different one.)

Memory Errors

1. Make sure that the DIMM modules are properly installed and fully seated in the slots.
2. You should be using ECC DDR4 2400 MHz (max.) memory recommended by the manufacturer. Also, it is recommended that you use the memory modules of the same type and speed for all DIMMs in the system. Do not use memory modules of different sizes, speeds and types on the same motherboard.
3. Check for bad DIMM modules or slots by swapping modules between slots to see if you can locate the faulty ones.
4. Check the switch of 115V/230V power supply.

Losing the System's Setup Configuration

1. Please be sure to use a high quality power supply. A poor quality power supply may cause the system to lose CMOS setup information. Refer to Section 1-6 for details on recommended power supplies.
2. The battery on your motherboard may be old. Check to verify that it still supplies ~3VDC. If it does not, replace it with a new one.
3. If the above steps do not fix the Setup Configuration problem, contact your vendor for repairs.

3-2 Technical Support Procedures

Before contacting Technical Support, please make sure that you have followed all the steps listed below. Also, Note that as a motherboard manufacturer, Supermicro does not sell directly to end users, so it is best to first check with your distributor or reseller for troubleshooting services. They should know of any possible problem(s) with the specific system configuration that was sold to you.

1. Please go through the 'Troubleshooting Procedures' and 'Frequently Asked Question' (FAQ) sections in this chapter or see the FAQs on our website (<http://www.supermicro.com/support/faqs/>) before contacting Technical Support.
2. BIOS upgrades can be downloaded from our website at (<http://www.supermicro.com/support/bios/>).



Note: Not all BIOS can be flashed. Some cannot be flashed; it depends on the boot block code of the BIOS.

3. If you've followed the instructions above to troubleshoot your system, and still cannot resolve the problem, then contact Supermicro's technical support and provide them with the following information:
 - Motherboard model and PCB revision number
 - BIOS release date/version (this can be seen on the initial display when your system first boots up)
 - System configuration
 - An example of a Technical Support form is on our website at (<http://www.supermicro.com/support/contact.cfm>).
4. Distributors: For immediate assistance, please have your account number ready when placing a call to our technical support department. We can be reached by e-mail at support@supermicro.com, by phone at: (408) 503-8000, option 2, or by fax at (408)503-8019.

3-3 Frequently Asked Questions

Question: What type of memory does my motherboard support?

Answer: The X10SRW-F supports up to 256GB of RDIMM and 512Gb of LRDIMM DDR4 2400 MHz (max.) in eight memory slots. See Section 2-5 for details on installing memory.

Question: How do I update my BIOS?

Answer: We do NOT recommend that you upgrade your BIOS if you are not experiencing any problems with your system. Updated BIOS files are located on our website at <http://www.supermicro.com/support/bios/>. Please check our BIOS warning message and the information on how to update your BIOS on our web site. Select your motherboard model and download the BIOS ROM file to your computer. Also, check the current BIOS revision to make sure that it is newer than your BIOS before downloading. You may choose the zip file. If you choose the zipped BIOS file, please unzip the BIOS file onto a bootable device or a USB pen/thumb drive. To flash the BIOS, run the batch file named "ami.bat" with the new BIOS ROM file from your bootable device or USB pen/thumb drive. Use the following format:

```
F:\> ami.bat BIOS-ROM-filename.xxx <Enter>
```

 **Note:** Always use the file named "ami.bat" to update the BIOS, and insert a space between "ami.bat" and the filename. The BIOS-ROM-filename will bear the motherboard name (i.e., X10SRW-F) and build version as the extension. For example, "X10SRW-F.115".

When the BIOS flashing screen is completed, power off to reboot the system. Power on and at this point, you will need to load the BIOS defaults. Press to go to the BIOS setup screen, and select "Restore Defaults" to load the default settings. Next, press <F4> to save and exit. Then reboot the system.

Warning: Do not shut down or reset the system while updating the BIOS to prevent possible system boot failure!

 **Note:** The SPI BIOS chip installed on this motherboard is not removable. To repair or replace a damaged BIOS chip, please send your motherboard to RMA at Supermicro for service.

Question: I think my BIOS is corrupted. How can I recover my BIOS?

Answer: Please see Appendix C-BIOS Recovery for detailed instructions.

Question: What is the heatsink part number for my X10SRW-F motherboard?

Answer: For the 1U passive heatsink, use SNK-P0047PS (back plate is included).

3-4 Battery Removal and Installation

Battery Removal

To remove the onboard battery, follow the steps below:

1. Power off your system and unplug your power cable.
2. Locate the onboard battery as shown below.
3. Using a tool such as a pen or a small screwdriver, push the battery lock outwards to unlock it. Once unlocked, the battery will pop out from the holder.
4. Remove the battery.

Proper Battery Disposal

Warning: Please handle used batteries carefully. Do not damage the battery in any way; a damaged battery may release hazardous materials into the environment. Do not discard a used battery in the garbage or a public landfill. Please comply with the regulations set up by your local hazardous waste management agency to dispose of your used battery properly.

Battery Installation

1. To install an onboard battery, follow the steps 1 and 2 above and continue below:
2. Identify the battery's polarity. The positive (+) side should be facing up.
3. Insert the battery into the battery holder and push it down until you hear a click to ensure that the battery is securely locked.

Warning: When replacing a battery, be sure to only replace it with the same type.

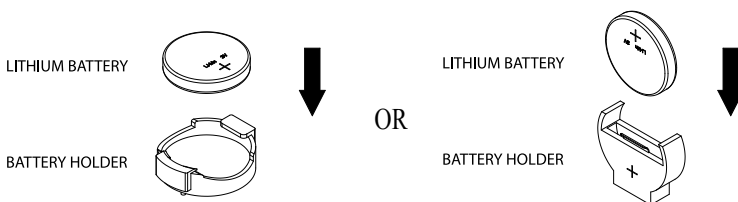

3-5 Returning Merchandise for Service

A receipt or copy of your invoice marked with the date of purchase is required before any warranty service will be rendered. You can obtain service by calling your vendor for a Returned Merchandise Authorization (RMA) number. For faster service, you may also obtain RMA authorizations online (<http://www.supermicro.com/RmaForm/>). When you return the motherboard to the manufacturer, the RMA number should be prominently displayed on the outside of the shipping carton, and mailed prepaid or hand-carried. Shipping and handling charges will be applied for all orders that must be mailed when service is complete.

This warranty only covers normal consumer use and does not cover damages incurred in shipping or from failure due to the alteration, misuse, abuse or improper maintenance of products.

During the warranty period, contact your distributor first for any product problem.

Chapter 4

UEFI BIOS

4-1 Introduction

This chapter describes the AMI BIOS setup utility for the X10SRW-F. The ROM BIOS is stored in a Flash EEPROM and can be easily updated. This chapter describes the basic navigation of the AMI BIOS setup utility screens.



Note: For AMI BIOS recovery, please refer to the UEFI BIOS Recovery Instructions in Appendix C.

Starting BIOS Setup Utility

To enter the AMI BIOS setup utility screens, press the <Delete> key while the system is booting up.



Note: In most cases, the <Delete> key is used to invoke the AMI BIOS setup screen. There are a few cases when other keys are used, such as <F1>, <F2>, etc.

Each main BIOS menu option is described in this manual. The AMI BIOS setup menu screen has two main frames. The left frame displays all the options that can be configured. Grayed-out options cannot be configured. Options in blue can be configured by the user. The right frame displays the key legend. Above the key legend is an area reserved for a text message. When an option is selected in the left frame, it is highlighted in white. Often a text message will accompany it.



Note: The AMI BIOS has default text messages built in. Supermicro retains the option to include, omit, or change any of these text messages.

The AMI BIOS setup utility uses a key-based navigation system called "hot keys." Most of the AMI BIOS setup utility "hot keys" can be used at any time during the setup navigation process. These keys include <F1>, <F4>, <Enter>, <Esc>, arrow keys, etc.



Note: Options printed in **Bold** are default settings.

How To Change the Configuration Data

The configuration data that determines the system parameters may be changed by entering the AMI BIOS setup utility. This setup utility can be accessed by pressing at the appropriate time during system boot.

How to Start the Setup Utility

Normally, the only visible Power-On Self-Test (POST) routine is the memory test. As the memory is being tested, press the <Delete> key to enter the main menu of the AMI BIOS setup utility. From the main menu, you can access the other setup screens. An AMI BIOS identification string is displayed at the left bottom corner of the screen, below the copyright message.

Warning: Do not upgrade the BIOS unless your system has a BIOS-related issue. Flashing the wrong BIOS can cause irreparable damage to the system. In no event shall Supermicro be liable for direct, indirect, special, incidental, or consequential damages arising from a BIOS update. If you have to update the BIOS, do not shut down or reset the system while the BIOS is updating. This is to avoid possible boot failure.

4-2 Main Setup

When you first enter the AMI BIOS setup utility, you will enter the Main setup screen. You can always return to the Main setup screen by selecting the Main tab on the top of the screen. The Main BIOS setup screen is shown below.

The following Main menu items will be displayed:

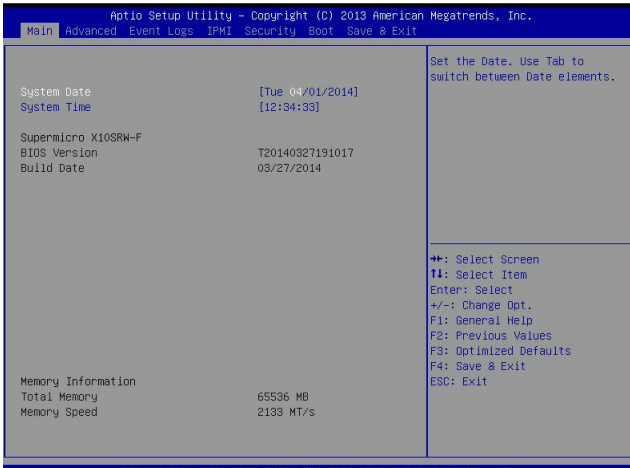

System Date/System Time

Use this option to change the system date and time. Highlight *System Date* or *System Time* using the arrow keys. Enter new values using the keyboard. Press the <Tab> key or the arrow keys to move between fields. The date must be entered in MM/DD/YYYY format. The time is entered in HH:MM:SS format.



Note: The time is in the 24-hour format. For example, 5:30 P.M. appears as 17:30:00.

Supermicro X10SRW-F**BIOS Version**

This item displays the version of the BIOS ROM used in the system.

Build Date

This item displays the date when the version of the BIOS ROM used in the system was built.

Memory Information**Total Memory**

This item displays the total size of memory available in the system.

Memory Speed

This item displays the default speed of the memory modules installed in the system.

4-3 Advanced Setup Configurations

Use the arrow keys to select Advanced setup and press <Enter> to access the submenu items:

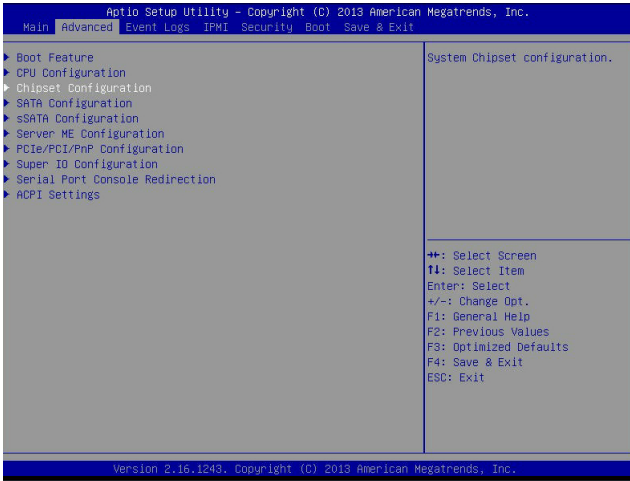

Warning: Take Caution when changing the Advanced settings. An incorrect value, a very high DRAM frequency or an incorrect BIOS timing setting may cause the system to malfunction. When this occurs, restore the setting to the manufacture default setting.

► Boot Feature

Quiet Boot

Use this feature to select the screen between displaying POST messages or the OEM logo at bootup. Select Disabled to display the POST messages. Select Enabled to display the OEM logo instead of the normal POST messages. The options are **Enabled** and Disabled.

AddOn ROM Display Mode

Use this feature to set the display mode for the Option ROM. Select Keep Current to use the current AddOn ROM display setting. Select Force BIOS to use the Option ROM display mode set by the system BIOS. The options are **Force BIOS** and Keep Current.

Bootup Num-Lock

Use this feature to set the Power-on state for the Numlock key. The options are Off and **On**.

Wait For 'F1' If Error

Select Enabled to force the system to wait until the 'F1' key is pressed if an error occurs. The options are Disabled and **Enabled**.

INT19 (Interrupt 19) Trap Response

Interrupt 19 is the software interrupt that handles the boot disk function. When this item is set to Immediate, the ROM BIOS of the host adapters will "capture" Interrupt 19 at bootup immediately and allow the drives that are attached to these host adapters to function as bootable disks. If this item is set to Postponed, the ROM BIOS of the host adapters will not capture Interrupt 19 immediately and allow the drives attached to these adapters to function as bootable devices at bootup. The options are **Immediate** and Postponed.

Re-try Boot

When EFI Boot is selected, the system BIOS will automatically reboot the system from an EFI boot device after its initial boot failure. Select Legacy Boot, to allow the BIOS to automatically reboot the system from a Legacy boot device after its initial boot failure. The options are **Disabled**, Legacy Boot, and EFI Boot.

Power Configuration**Watch Dog Function**

Select Enabled to allow the Watch Dog timer to reboot the system when it is inactive for more than five minutes. The options are Enabled and **Disabled**.

Power Button Function

This feature controls how the system shuts down when the power button is pressed. Select 4 Seconds Override for the user to power off the system after pressing and holding the power button for 4 seconds or longer. Select Instant Off to instantly power off the system as soon as the user presses the power button. The options are 4 Seconds Override and **Instant Off**.

Restore on AC Power Loss

Use this feature to set the power state after a power outage. Select Stay Off for the system power to remain off after a power loss. Select Power-On for the system power to be turned on after a power loss. Select Last State to allow the system to resume its last power state before a power loss. The options are Stay On, Stay-Off and **Last State**.

► Chipset Configuration

Warning! Setting the wrong values in the following sections may cause the system to malfunction.

CPU Configuration

The following CPU information will be displayed:

- Processor Socket
- Processor ID
- Processor Frequency
- Max (Maximum) CPU Speed
- Min (Minimum) CPU Speed
- Processor Max Ratio
- Processor Min Ratio
- Microcode Revision
- L1 Cache RAM
- L2 Cache RAM
- L3 Cache RAM
- CPU1 Version

Clock Spread Spectrum

Select Enable for Clock Spectrum support, which will allow the BIOS to monitor and attempt to reduce the level of Electromagnetic Interference caused by the components whenever needed. Select Disabled to enhance system stability. The options are **Disabled** and Enabled.

Hyper-Threading

Select Enable to use Intel Hyper-Threading Technology to enhance CPU performance. The options are **Enable** and Disable.

Performance/Watt

Select Power Optimized to use Intel Turbo Boost Technology to maximize system performance (with maximum cooling) when performance state P0 lasts more than two seconds. If Traditional is selected, Intel Turbo Boost Technology will be activated even when performance state P0 lasts less than two seconds. The options are **Traditional** and Power Optimized.

Execute Disable Bit (Available if supported by the OS & the CPU)

Set to Enabled for Execute Disable Bit support, which will allow the processor to designate areas in the system memory where an application code can execute and where it cannot, thus preventing a worm or a virus from flooding illegal codes to overwhelm the processor or damaging the system during a virus attack. The options are **Enable** and Disable. (Refer to Intel and Microsoft websites for more information.)

PPIN Control

Select Unlock/Enable to use the Protected-Processor Inventory Number (PPIN) in the system. The options are **Unlock/Enable** and Unlock/Disable.

Hardware Prefetcher (Available when supported by the CPU)

If this item is set to Enable, the hardware prefetcher will prefetch streams of data and instructions from the main memory to the Level 2 (L2) cache to improve CPU performance. The options are Disable and **Enable**.

Adjacent Cache Line Prefetch (Available when supported by the CPU)

Select Enable for the CPU to prefetch both cache lines for 128 bytes as comprised. Select Disable for the CPU to prefetch both cache lines for 64 bytes. The options are Disable and **Enable**.



Note: If there is any change to this setting, you will need to power off and reboot the system for the change to take effect. Please refer to Intel's website for detailed information.

DCU Streamer Prefetcher (Available when supported by the CPU)

If this item is set to Enable, the DCU (Data Cache Unit) streamer prefetcher will prefetch data streams from the cache memory to the DCU (Data Cache Unit) to speed up data accessing and processing for CPU performance enhancement. The options are Disable and **Enable**.

DCU IP Prefetcher

If this item is set to Enable, the IP prefetcher in the DCU (Data Cache Unit) will prefetch IP addresses to improve network connectivity and system performance. The options are **Enable** and Disable.

DCU (Data Cache Unit) Mode

Use this item to set the DCU data-prefecting mode. The options are **32KB 8Way Without ECC** and **16KB 4Way With ECC**.

Direct Cache Access (DCA)

Select Enable to use Intel DCA (Direct Cache Access) Technology to maximize efficiency in memory data transferring and accessing. The options are **Auto**, Enable and Disable.

DCA Prefetch Delay

A DCA prefetcher is used with a TOE (TCP/IP Offload Engine) adapter to prefetch data to shorten execution cycles and to maximize data processing efficiency. Prefetching data too frequently can saturate the cache directory and delay necessary cache access. This feature reduces or increases the frequency of system data prefetching activities. The options are Disable, [8], [16], **[32]**, [40], [48], [56], [64], [72], [80], [88], [96], [104], and [112].

X2APIC (Extended Advanced Programmable Interrupt Controller)

Based on the Intel Hyper-Threading technology, each logical processor (thread) is assigned 256 APIC IDs (APIDs) in 8-bit bandwidth. When this item is set to Enable, the APIC ID will be expanded from 8 bits to 16 bits to provide 512 APIDs to each thread to enhance CPU performance. The options are **Disable** and Enable.

AES-NI

Select Enable to use the Intel Advanced Encryption Standard (AES) New Instructions (NI) to ensure data security. The options are **Enable** and Disable.

Intel Virtualization Technology

Select Enable to use Intel Virtualization Technology so that I/O device assignments will be reported directly to the VMM (Virtual Memory Management) through the DMAR ACPI Tables. This feature offers fully-protected I/O resource-sharing across the Intel platforms, providing the user with greater reliability, security and availability in networking and data-sharing. The settings are **Enable** and Disable.

► Advanced Power Management Configuration

Power Technology

Select Energy Efficient to support power-saving mode. Select Custom to customize system power settings. Select Disabled to disable power-saving settings. The options are Disable, **Energy Efficient**, and Custom.

Config TDP

Select Enable to allow the user to configure the Thermal Design Power (TDP) settings for the system. The TDP refers to the maximum amount of power allowed for running "real applications" without triggering an overheating event. The options are **Disable** and **Enable**.

► CPU P State Control

EIST (P-State)

EIST (Enhanced Intel SpeedStep Technology) allows the system to automatically adjust processor voltage and core frequency in an effort to reduce power consumption and heat dissipation. Please refer to Intel's website for detailed information. The options are **Disable** and **Enable**.

Turbo Mode

Select Enable for processor cores to run faster than the frequency specified by the manufacturer. The options are **Disable** and **Enable**.

P-state Coordination

Use this item to configure the processor's P-State coordination settings. During a P-State, the voltage and frequency of the processor will be reduced when it is in operation. This makes the processor more energy efficient, resulting in further energy gains. The options are **HW_ALL**, **SW_ALL** and **SW-ANY**.

► CPU C State Control

Package C State limit

Use this item to set the limit on the C-State package register. The options are **C0/1 state**, **C2 state**, **C6 (non-Retention) state**, and **C6 (Retention) state**.

CPU C3 Report

Select Enable to allow the BIOS to report the CPU C3 State (ACPI C2) to the operating system. During the CPU C3 State, the CPU clock generator is turned off. The options are **Enable** and **Disable**.

CPU C6 Report (Available when Power Technology is set to Custom)

Select Enable to allow the BIOS to report the CPU C6 state (ACPI C3) to the operating system. During the CPU C6 state, power to all caches is turned off. The options are **Enable** and **Disable**.

Enhanced Halt State (C1E)

Select Enabled to enable "Enhanced Halt State" support, which will significantly reduce the CPU's power consumption by minimizing CPU's clock cycles and voltage use during a "Halt State." The options are Disable and **Enable**.

▶ CPU T State Control

ACPI (Advanced Configuration Power Interface) T-States

If this item is set to Enable, CPU throttling will be supported by the operating system to reduce power consumption. The options are **Enable** and Disable.

▶ Socket RAPL (Running Average Power Limit) Configuration

FAST_RAPL_NSTRIKE_PL2_DUTY_CYCLE

This feature displays the value of the item above within the range between 25 (10%) and 64 (25%).

Turbo Power Limit Lock

Select Enable to set the power use limit for the machine when it is running in the turbo mode. The options are Enable and **Disable**.

Long Power Limit Override

Select Enable to support long-term power limit override. If this feature is disabled, BIOS will set the default value. The options are Enable and **Disable**.

Long Duration Power Limit

This item displays the power limit set by the user during which long duration power is maintained. The default setting is **0**.

Package Clamping Limit1

Use this item to set the limit on power performance states for the run-time processor, with P0 being the state with the highest frequency (clock speed) and power (consumption), and P1, a step lower in performance than P0, with its frequency and voltage scaled back a notch. The options are Between P1/P0 and **Below P1**.

Short Duration Power Limit Enable

Select Enable to support Short Duration Power Limit (Power Limit 2). The options are **Enable** and Disable.

Short Duration Power Limit

This item displays the time period during which short duration power is maintained. The default setting is **0**.

Package Clamping Limit2

Use this item to set the limit on power performance states for the processor operating in turbo mode, with P0 being the state with the highest frequency (clock speed) and power (consumption), and P1, a step lower in performance than P0, with its frequency and voltage scaled back a notch. The options are Between P1/P0 and **Below P1**.

► Chipset Configuration

► North Bridge

This feature allows the user to configure the settings for the Intel North Bridge.

► IIO Configuration

EV DFX (Device Function On-Hide) Feature

When this feature is set to Enable, the EV_DFX Lock Bits that are located on a processor will always remain clear during electric tuning. The options are **Disable** and Enable.

► IIO1 Configuration/IIO2 Configuration

IOU2 (IIO PCIe Port 1)

This item configures the PCI-E port Bifurcation setting for a PCI-E port specified by the user. The options are x4x4, X8, and **Auto**.

PORT 1A Link Speed

This item configures the link speed of a PCI-E port specified by the user. The options are Gen 1 (Generation 1) (2.5 GT/s), Gen 2 (Generation 2) (5 GT/s), and **Gen 3 (Generation 3) (8 GT/s)**.

IOU0 (IIO PCIe Port 2)

This item configures the PCI-E port Bifurcation setting for a PCI-E port specified by the user. The options are x4x4x4x4, x4x4x8, x8x4x4, x8x8, x16, and **Auto**

PORT 2A Link Speed

Use this item to configure the link speed of a PCI-E port specified by the user. The options are Gen 1 (Generation 1) (2.5 GT/s), Gen 2 (Generation 2) (5 GT/s), and **Gen 3 (Generation 3) (8 GT/s)**.

IOU1 (IIO PCIE Port 3)

Use this item to configure the PCI-E port Bifurcation setting for a PCI-E port specified by the user. The options are x4x4x4x4, x4x4x8, x8x4x4, x8x8, x16, and **Auto**.

PORT 3A Link Speed

Use this item to configure the link speed of a PCI-E port specified by the user. The options are Gen 1 (Generation 1) (2.5 GT/s), Gen 2 (Generation 2) (5 GT/s), and **Gen 3 (Generation 3) (8 GT/s)**.

PCI-E Completion Timeout

Select Enable for PCI-E Completion Timeout support for electric tuning. The options are **Enable** and Disable.

PCI-E Completion Timeout Value

Use this item to set the PCI-E Completion Time-out value for electric tuning. Enter a value between 260ms to 900ms.

► IOAT Configuration

Enable I/OAT

Select Enable to enable Intel I/OAT (I/O Acceleration Technology), which significantly reduces CPU overhead by leveraging CPU architectural improvements and freeing the system resource for other tasks. The options are **Enable** and Disable.

No Snoop

Select Enable to support no-snoop mode for each CB device. The options are **Disable** and Enable.

Relaxed Ordering

Select Enable to enable Relaxed Ordering support, which will allow certain transactions to violate the strict-ordering rules of PCI and to be completed prior to other transactions that have already been enqueued. The options are **Disable** and Enable.

► Intel VT for Directed I/O (VT-d)

Intel VT for Direct I/O (VT-d)

Intel® VT for Directed I/O (VT-d)

Select Enable to use Intel Virtualization Technology support for Direct I/O VT-d support by reporting the I/O device assignments to the VMM (Virtual Machine Monitor) through the DMAR ACPI Tables. This feature offers fully-protected I/O resource sharing across Intel platforms, providing greater reliability, security and availability in networking and data-sharing. The options are **Enable** and Disable.

Interrupt Remapping

Select Enable for Interrupt Remapping support to enhance system performance. The options are **Enable** and Disable.

Coherency Support (Non-Iscoch)

Select Enable for the Non-Iscoch VT-d engine to pass through DMA (Direct Memory Access) to enhance system performance. The options are Enable and **Disable**.

Coherency Support (Iscoch)

Select Enable for the Iscoch VT-d engine to pass through ATS to enhance system performance. The options are Enable and **Disable**.

► QPI (Quick Path Interconnect) Configuration

QPI Status

The following information will display:

- Number of CPU
- Number of IIO

Link Speed Mode

Use this item to select the data transfer speed for QPI Link connections. The options are **Fast** and Slow.

Link Frequency Select

Use this item to select the desired frequency for QPI Link connections. The options are 6.4GB/s, 8.0GB/s, 9.6GB/s, **Auto**, and Auto Limited.

Link L0p Enable

Select Enable for Link L0p support. The options are Enable, **Auto**, and Disable.

Link L1 Enable

Select Enable for Link L1 support. The options are Enable, **Auto**, and Disable.

Isoc Mode

Select Enabled for Isochronous support to meet QoS (Quality of Service) requirements. This feature is especially important for Virtualization Technology. The options are Enable and **Disable**.

► Memory Configuration

Enforce POR

Select Enable to enforce POR restrictions for DDR4 frequency and voltage programming. The options are **Enabled** and Disabled.

Memory Frequency

Use this feature to set the maximum memory frequency for onboard memory modules. The options are **Auto**, 1333, 1400, 1600, 1800, 1867, 2000, 2133, 2200, 2400, 2600, 2667, and Reserved (Do not select Reserved).

ECC Support

Select Enable to enable Error Checking & Correction (ECC) support for onboard memory modules. The options are **Auto**, Enable and Disable.

Data Scrambling

Select Enabled to enable data scrambling to enhance system performance and data integrity. The options are **Auto**, Disabled and Enabled.

Enable ADR

Select Enabled for ADR (Automatic Diagnostic Repository) support to enhance memory performance. The options are Enabled and **Disabled**.

DRAM RAPL (Running Average Power Limit) Baseline

Use this feature to set the run-time power-limit baseline for DRAM modules. The options are Disable, DRAM RAPL Mode 0, and **DRAM RAPL Mode 1**.

Set Throttling Mode

Throttling improves reliability and reduces power consumption in the processor via automatic voltage control during processor idle states. The options are Disabled and **CLTT** (Closed Loop Thermal Throttling).

Socket Interleave Below 4GB

Select Enabled for the memory above the 4G Address space to be split between two sockets. The options are Enable and **Disable**.

Channel Interleaving

Use this item to set DIMM channel interleaving mood. The options are **Auto**, 1 Way Interleave, 2 Way Interleave, 3, Way Interleave, and 4 Way Interleave.

Rank Interleaving

Use this item to select a rank memory interleaving method. The options are **Auto**, 1 Way, 2 Way, 4, Way, and 8 Way.

A7 Mode

Select Enabled to support A7 (Addressing) Mode to improve memory performance. The options are **Enable** and Disable.

►DIMM Information

This item displays the status of a DIMM module specified.

- DIMMA1
- DIMMA2
- DIMMB1
- DIMMB2
- DIMMC1
- DIMMC2
- DIMMD1
- DIMMD2

►Memory RAS (Reliability, Availability, and Serviceability) Configuration

Use this submenu to configure the following Memory RAS settings.

RAS Mode

Select Enable to enable RAS support to enhance reliability, availability and serviceability of onboard memory modules. The options are Enable and **Disable**.

Lockstep x4 DIMMs

Select Enable to enable Lockstep Technology support for x4 DIMM modules. The options are **Auto**, Disabled, and Enabled.

Memory Rank Sparing

This item indicates if memory rank sparing is supported by the motherboard. Memory rank sparing enhances system memory performance. The options are Enabled and **Disabled**.

Patrol Scrub

Patrol Scrubbing is a process that allows the CPU to correct correctable memory errors detected in a memory module and send the correction to the requestor (the original source). When this item is set to Enable, the IO hub will read and write back one cache line every 16K cycles if there is no delay caused by internal processing. By using this method, roughly 64 GB of memory behind the IO hub will be scrubbed every day. The options are **Enable** and Disable.

Patrol Scrub Interval

Use this item to specify the number of hours (between 0 to 24) required for the system to complete a full patrol scrubbing. Enter 0 for patrol scrubbing to be performed automatically. The default setting is **24**.

Demand Scrub

Demand Scrubbing is a process that allows the CPU to correct correctable memory errors found in a memory module. When the CPU or I/O issues a demand-read command, and the read data from memory turns out to be a correctable error, the error is corrected and sent to the requestor (the original source). Memory is corrected as well. Select Enable to use Demand Scrubbing for ECC memory correction. The options are **Enable** and Disable.

Device Tagging

Select Enable to support device tagging. The options are **Disable** and Enable.

►South Bridge

The following South Bridge information will display:

- USB Configuration
- USB Module Version
- USB Devices

Legacy USB Support

Select Enabled to support onboard legacy USB devices. Select Auto to disable legacy support if there are no legacy USB devices present. Select Disable to have all USB devices available for EFI applications only. The options are **Enabled**, Disabled, and Auto.

XHCI Hand-Off

This is a work-around solution for operating systems that do not support XHCI (Extensible Host Controller Interface) hand-off. The XHCI ownership change should be claimed by the XHCI driver. The settings are **Enabled** and Disabled.

EHCI Hand-Off

This item is for operating systems that do not support Enhanced Host Controller Interface (EHCI) hand-off. When this item is enabled, EHCI ownership change will be claimed by the EHCI driver. The settings are Enabled and **Disabled**.

USB Mass Storage Driver Support

Select Enabled for USB mass storage device support. The options are Disabled and **Enabled**.

Port 60/64 Emulation

Select Enabled for I/O port 60h/64h emulation support, which in turn, will provide complete legacy USB keyboard support for the operating systems that do not support legacy USB devices. The options are Disabled and **Enabled**.

USB 3.0 Support

Select Enabled for USB 3.0 support. The options are Disabled, Enabled and **Auto**.

EHCI1

Select Enabled to enable EHCI (Enhanced Host Controller Interface) support on USB 2.0 connector #1 (at least one USB 2.0 connector should be enabled for EHCI support). The options are Disabled and **Enabled**.

EHCI2

Select Enabled to enable EHCI (Enhanced Host Controller Interface) support on USB 2.0 connector #2 (at least one USB 2.0 connector should be enabled for EHCI support). The options are Disabled and **Enabled**.

XHCI Pre-Boot Drive

Select Enabled to enable XHCI (Extensible Host Controller Interface) support on a pre-boot drive specified by the user. The options are Enabled and **Disabled**.

XHCI Idle L1

Select Enabled for XHCI (Extensible Host Controller Interface) Idle Level 1 support on a USB 3.0 connector specified by the user. The options are **Enabled** and Disabled.

PCH DMI ASPM

Select Enabled to enable ASPM (Active State Power Management) support for a PCH DMI drive. The options are **Disabled** and Enabled.

►SATA Configuration

When this submenu is selected, the AMI BIOS automatically detects the presence of the SATA devices that are supported by the Intel PCH chip and displays the following items:

SATA Controller

This item enables or disables the onboard SATA controller supported by the Intel PCH chip. The options are **Enabled** and Disabled.

Configure SATA as

Select IDE to configure a SATA drive specified by the user as an IDE drive. Select AHCI to configure a SATA drive specified by the user as an AHCI drive. Select RAID to configure a SATA drive specified by the user as a RAID drive. The options are IDE, **AHCI**, and RAID.

****If the item above "Configure SATA as" is set to AHCI, the following items will display:***

Support Aggressive Link Power Management

When this item is set to Enabled, the SATA AHCI controller manages the power usage of the SATA link. The controller will put the link in a low power mode during extended periods of I/O inactivity, and will return the link to an active state when I/O activity resumes. The options are **Enabled** and Disabled.

SATA Port 0~ Port 5

This item displays the information detected on the installed SATA drive on the particular SATA port.

- Model number of drive and capacity
- Software Preserve Support

Port 0~ Port 5

Select Enabled to enable a SATA port specified by the user. The options are Disabled and **Enabled**.

Port 0 ~ Port 5 Hot Plug

This feature designates the port specified for hot plugging. Set this item to Enabled for hot-plugging support, which will allow the user to replace a SATA disk drive without shutting down the system. The options are **Enabled** and Disabled.

Port 0 ~ Port 5 Spin Up Device

On an edge detect from 0 to 1, set this item to allow the PCH to initialize the device. The options are Enabled and **Disabled**.

Port 0 ~ Port 5 SATA Device Type

Use this item to specify if the SATA port specified by the user should be connected to a Solid State drive or a Hard Disk Drive. The options are Hard Disk Drive and Solid State Drive.

****If the item above "Configure SATA as" is set to IDE, the following items will display:***

Serial ATA Port 0~ Port 5

This item indicates that a SATA port specified by the user is not installed or not present.

Port 0 ~ Port 5 SATA Device Type (Available when a SATA port is detected)

Use this item to specify if the SATA port specified by the user should be connected to a Solid State Drive or a Hard Disk Drive. The options are Hard Disk Drive and Solid State Drive.

****If the item above "Configure SATA as" is set to RAID, the following items will display:***

Support Aggressive Link Power Management

When this item is set to Enabled, the SATA AHCI controller manages the power usage of the SATA link. The controller will put the link in a low power mode during extended periods of I/O inactivity, and will return the link to an active state when I/O activity resumes. The options are **Enabled** and Disabled.

SATA RAID Option ROM/UEFI Driver

Select EFI to load the EFI driver for system boot. Select Legacy to load a legacy driver for system boot. The options are Disabled, **EFI**, and Legacy.

Serial ATA Port 0~ Port 5

This item displays the information detected on the installed SATA drives on the particular SATA port.

- Model number of drive and capacity
- Software Preserve Support

Port 0~ Port 5

Select Enabled to enable a SATA port specified by the user. The options are Disabled and **Enabled**.

Port 0 ~ Port 5 Hot Plug

This feature designates this port for hot plugging. Set this item to Enabled for hot-plugging support, which will allow the user to replace a SATA drive without shutting down the system. The options are Enabled and **Disabled**.

Port 0 ~ Port 5 Spin Up Device

On an edge detect from 0 to 1, set this item to allow the PCH to start a COMRESET initialization to the device. The options are Enabled and **Disabled**.

Port 0 ~ Port 5 SATA Device Type

Use this item to specify if the SATA port specified by the user should be connected to a Solid State drive or a Hard Disk Drive. The options are Hard Disk Drive and Solid State Drive.

►sSATA Configuration

When this submenu is selected, the AMI BIOS automatically detects the presence of the SATA devices that are supported by the SCU controller and displays the following items:

sSATA Controller

This item enables or disables the onboard SATA controller supported by the Intel SCU chip. The options are **Enabled** and Disabled.

Configure sSATA as

Select IDE to configure an sSATA drive specified by the user as an IDE drive. Select AHCI to configure an sSATA drive specified by the user as an AHCI drive. Select RAID to configure an sSATA drive specified by the user as a RAID drive. The options are IDE, **AHCI**, and RAID.

****If the item above "Configure sSATA as" is set to AHCI, the following items will display:***

Support Aggressive Link Power Management

When this item is set to Enabled, the sSATA AHCI controller manages the power usage of the sSATA link. The controller will put the link in a low power mode during extended periods of I/O inactivity, and will return the link to an active state when I/O activity resumes. The options are **Enabled** and Disabled.

sSATA Port 0~ Port 3

This item displays the information detected on the installed sSATA drives on the particular sSATA port.

- Model number of drive and capacity
- Software Preserve Support

sSATA Port 0~ Port 3

Select Enabled to enable an sSATA port specified by the user. The options are Disabled and **Enabled**.

sSATA Port 0 ~ Port 3 Hot Plug

This feature designates the sSATA port specified for hot plugging. Set this item to Enabled for hot-plugging support, which will allow the user to replace an sSATA disk drive without shutting down the system. The options are **Enabled** and Disabled.

sSATA Port 0 ~ Port 3 Spin Up Device

On an edge detect from 0 to 1, set this item to allow the PCH to start a COMRESET initialization to the device. The options are Enabled and **Disabled**.

Port 0 ~ Port 3 sSATA Device Type

Use this item to specify if the sSATA port specified by the user should be connected to a Solid State Drive or a Hard Disk Drive. The options are Hard Disk Drive and Solid State Drive.

****If the item above "Configure sSATA as" is set to IDE, the following items will display:***

sSATA Port 0~ Port 3

This item indicates that an sSATA port specified by the user is not installed or not detected.

Port 0 ~ Port 3 sSATA Device Type (Available when a SATA port is detected)

Use this item to specify if the sSATA port specified by the user should be connected to a Solid State Drive or a Hard Disk Drive. The options are Hard Disk Drive and Solid State Drive.

****If the item above "Configure sSATA as" is set to RAID, the following items will display:***

Support Aggressive Link Power Management

When this item is set to Enabled, the SATA AHCI controller manages the power usage of the SATA link. The controller will put the link in a low power mode during extended periods of I/O inactivity, and will return the link to an active state when I/O activity resumes. The options are **Enabled** and Disabled.

sSATA RAID Option ROM/UEFI Driver

Select EFI to load the EFI driver for system boot. Select Legacy to load a legacy driver for system boot. The options are Disabled, **EFI**, and Legacy.

sSATA Port 0~ Port 3

This item displays the information detected on the installed sSATA drives on the particular sSATA port.

- Model number of drive and capacity
- Software Preserve Support

sSATA Port 0~ Port 3

Select Enabled to enable an sSATA port specified by the user. The options are Disabled and **Enabled**.

sSATA Port 0 ~ Port 3 Hot Plug

This feature designates this port for hot plugging. Set this item to Enabled for hot-plugging support, which will allow the user to replace an sSATA drive without shutting down the system. The options are Enabled and **Disabled**.

sSATA Port 0 ~ Port 3 Spin Up Device

On an edge detect from 0 to 1, set this item to allow the PCH to start a COMRE-SET initialization to the device. The options are Enabled and **Disabled**.

Port 0 ~ Port 3 sSATA Device Type

Use this item to specify if the sSATA port specified by the user should be connected to a Solid State Drive or a Hard Disk Drive. The options are Hard Disk Drive and Solid State Drive.

► Server ME (Management Engine) Configuration

This feature displays the following system ME configuration settings.

- General ME Configuration
- Operational Firmware Version
- Recovery Firmware Version
- ME Firmware Features
- ME Firmware Status #1
- ME Firmware Status #2
 - Current State
 - Error Code

► PCIe/PCI/PnP Configuration

The following PCI information will be displayed:

- PCI Bus Driver Version
- PCI Latency Timer

PCI AER (Advanced Error-Reporting) Support

Use this item to configure the PCI-X latency timer for a device installed on a PCI-X bus. Select 64 to set the PCI-X latency timer to 64 PCI clock cycles. The options are **32**, 64, 96, 128, 160, 192, 224 and 248 (PCI Bus Clocks).

VGA Palette Snoop

Select Enabled to support VGA palette register snooping, which will allow a PCI card that does not contain its own VGA color palette to examine a video card palette and mimic it for proper color display. The options are **Disabled** and Enabled.

PERR# Generation Support

Select Enabled to allow a PCI device to generate a PERR (PCI/PCI-E Parity Error) number for a PCI bus error event. The options are Enabled and **Disabled**.

SERR# Generation Support

Select Enabled to allow a PCI device to generate an SERR (System Error) number for a PCI bus error event. The options are Enabled and **Disabled**.

Above 4G Decoding (Available if the system supports 64-bit PCI decoding)

Select Enabled to decode a PCI device that supports 64-bit in the space above 4G Address. The options are **Enabled** and Disabled.

SR-IOV Support (Available if the system supports Single-Root Virtualization)

Select Enabled for Single-Root IO Virtualization support. The options are Enabled and **Disabled**.

Maximum Payload

Select Auto for the system BIOS to automatically set the maximum payload value for a PCI-E device to enhance system performance. The options are **Auto**, 128 Bytes and 256 Bytes.

Maximum Read Request

Select Auto for the system BIOS to automatically set the maximum size for a read request for a PCI-E device to enhance system performance. The options are **Auto**, 128 Bytes, 256 Bytes, 512 Bytes, 1024 Bytes, 2048 Bytes, and 4096 Bytes.

ASPM Support

Use this item to set the Active State Power Management (ASPM) level for a PCI-E device. Select Auto for the system BIOS to automatically set the ASPM level based on the system configuration. Select Disabled to disable ASPM support. The options are **Disabled** and Auto.

Warning: Enabling ASPM support may cause some PCI-E devices to fail!

MMIOHBase

Use this item to select the base memory size according to memory-address mapping for the I/O hub. The base memory size must be between 4032G to 4078G. The options are **56T**, 48T, 24T, 512G, and 256G.\

MMIO High Size

Use this item to select the high memory size according to memory-address mapping for the I/O hub. The options are **256G**, 128G, 512G, and 1024G.

RSC-R2UW-2E8R Slot1 PCI-E x8 (OPROM)/RSC-R2UW-4E8 Slot4 PCI-E x8 (OPROM)/RSC-R2UW-4E8 Slot3 PCI-E x8 (OPROM)/RSC-R2UW-4E8 Slot1 PCI-E x8 (OPROM)/ RSC-R2UW-4E8 Slot2 PCI-E x8 (OPROM)

Select Enabled to enable Option ROM support to boot the computer using a device installed on the slot specified by the user. The options are Disabled, **Legacy**, and EFI.

Onboard LAN1 Option ROM/Onboard LAN2 Option ROM

Use this option to select the type of device installed in LAN Port1 or LAN Port2 used for system boot. The default setting for LAN1 Option ROM is **PXE**, and the default setting for LAN2 Option ROM is **Disabled**.

VGA Priority

Use this item to select the graphics device to be used as the primary video display at bootup. The options are **Onboard** and Offboard.

Network Stack

Select Enabled to enable PXE (Preboot Execution Environment) or UEFI (Unified Extensible Firmware Interface) for network stack support. The options are **Enabled** and Disabled.

Ipv6 PXE Support (Available when Network Stack is set to Enabled)

Select Enabled to enable Ipv6 PXE (Preboot Execution Environment) for boot support. If this feature is set to Disabled, Ipv6 PXE boot option will not be supported. The options are Enabled and **Disabled**.

► Super IO Configuration

Super IO Chip AST2400

► Serial Port 1 Configuration/Serial Port 2 Configuration

Serial Port 1/Serial Port 2

Select Enabled to enable the onboard serial port specified by the user. The options are **Enabled** and Disabled.

Device Settings

This item displays the base I/O port address and the Interrupt Request address of a serial port specified by the user.

Change Port 1 Settings/Change Port 2 Settings

This feature specifies the base I/O port address and the Interrupt Request address of Serial Port 1 or Serial Port 2. Select **Auto** for the BIOS to automatically assign the base I/O and IRQ address to a serial port specified.

The options for Serial Port 1 are **Auto**, (IO=3F8h; IRQ=4), (IO=3F8h; IRQ=3, 4, 5, 6, 7, 9, 10, 11, 12), (IO=2F8h; IRQ=3, 4, 5, 6, 7, 9, 10, 11, 12); (IO=3E8h; IRQ=3, 4, 5, 6, 7, 9, 10, 11, 12), and (IO=2E8h; IRQ=3, 4, 5, 6, 7, 9, 10, 11, 12).

The options for Serial Port 2 are **Auto**, (IO=3F8h; IRQ=4), (IO=3F8h; IRQ=3, 4, 5, 6, 7, 9, 10, 11, 12), (IO=2F8h; IRQ=3, 4, 5, 6, 7, 9, 10, 11, 12); (IO=3E8h; IRQ=3, 4, 5, 6, 7, 9, 10, 11, 12), and (IO=2E8h; IRQ=3, 4, 5, 6, 7, 9, 10, 11, 12).

Serial Port 2 Attribute

Select SOL to use COM Port 2 as a Serial_Over_LAN (SOL) port for console redirection. The options are COM and **SOL**.

► Serial Port Console Redirection

COM 1 Console Redirection

Select Enabled to enable COM Port 1 for Console Redirection, which will allow a client machine to be connected to a host machine at a remote site for networking. The options are Enabled and **Disabled**.

****If the item above set to Enabled, the following items will become available for configuration:***

► COM1 Console Redirection

Terminal Type

This feature allows the user to select the target terminal emulation type for Console Redirection. Select VT100 to use the ASCII Character set. Select VT100+ to add color and function key support. Select ANSI to use the Extended ASCII Character Set. Select VT-UTF8 to use UTF8 encoding to map Unicode characters into one or more bytes. The options are ANSI, VT100, **VT100+**, and VT-UTF8.

Bits Per second

Use this item to set the transmission speed for a serial port used in Console Redirection. Make sure that the same speed is used in the host computer and the client computer. A lower transmission speed may be required for long and busy lines. The options are 9600, 19200, 38400, 57600, and **115200** (bits per second).

Data Bits

Use this feature to set the data transmission size for Console Redirection. The options are 7 (Bits) and **8 (Bits)**.

Parity

A parity bit can be sent along with regular data bits to detect data transmission errors. Select Even if the parity bit is set to 0, and the number of 1's in data bits is even. Select Odd if the parity bit is set to 0, and the number of 1's in data bits is odd. Select None if you do not want to send a parity bit with your data bits in transmission. Select Mark to add a mark as a parity bit to be sent along with the data bits. Select Space to add a Space as a parity bit to be sent with your data bits. The options are **None**, Even, Odd, Mark, and Space.

Stop Bits

A stop bit indicates the end of a serial data packet. Select 1 Stop Bit for standard serial data communication. Select 2 Stop Bits if slower devices are used. The options are **1** and 2.

Flow Control

Use this item to set the flow control for Console Redirection to prevent data loss caused by buffer overflow. Send a "Stop" signal to stop sending data when the receiving buffer is full. Send a "Start" signal to start sending data when the receiving buffer is empty. The options are **None** and Hardware RTS/CTS.

VT-UTF8 Combo Key Support

Select Enabled to enable VT-UTF8 Combination Key support for ANSI/VT100 terminals. The options are **Enabled** and Disabled.

Recorder Mode

Select Enabled to capture the data displayed on a terminal and send it as text messages to a remote server. The options are **Disabled** and Enabled.

Resolution 100x31

Select Enabled for extended-terminal resolution support. The options are Disabled and **Enabled**.

Legacy OS Redirection Resolution

Use this item to select the number of rows and columns used in Console Redirection for legacy OS support. The options are 80x24 and **80x25**.

Putty KeyPad

This feature selects Function Keys and KeyPad settings for Putty, which is a terminal emulator designed for the Windows OS. The options are **VT100**, LINUX, XTERMR6, SCO, ESCN, and VT400.

Redirection After BIOS Post

Use this feature to enable or disable legacy Console Redirection after BIOS POST. When set to Bootloader, legacy Console Redirection is disabled before booting the OS. When set to Always Enable, legacy Console Redirection remains enabled when booting the OS. The options are **Always Enable** and Bootloader.

SOL/COM2

SOL/COM2 Console Redirection

Select Enabled to use the SOL port for Console Redirection. The options are **Enabled** and Disabled.

**If the item above set to Enabled, the following items will become available for user's configuration:*

► SOL/COM2 Console Redirection Settings

Use this feature to specify how the host computer will exchange data with the client computer, which is the remote computer used by the user.

Terminal Type

Use this feature to select the target terminal emulation type for Console Redirection. Select VT100 to use the ASCII Character set. Select VT100+ to add color and function key support. Select ANSI to use the Extended ASCII Character Set. Select VT-UTF8 to use UTF8 encoding to map Unicode characters into one or more bytes. The options are ANSI, VT100, **VT100+**, and VT-UTF8.

Bits Per second

Use this feature to set the transmission speed for a serial port used in Console Redirection. Make sure that the same speed is used in the host computer and the client computer. A lower transmission speed may be required for long and busy lines. The options are 9600, 19200, 38400, 57600 and **115200** (bits per second).

Data Bits

Use this feature to set the data transmission size for Console Redirection. The options are 7 (Bits) and **8 (Bits)**.

Parity

A parity bit can be sent along with regular data bits to detect data transmission errors. Select Even if the parity bit is set to 0, and the number of 1's in data bits is even. Select Odd if the parity bit is set to 0, and the number of 1's in data bits is odd. Select None if you do not want to send a parity bit with your data bits in transmission. Select Mark to add a mark as a parity bit to be sent along with the data bits. Select Space to add a Space as a parity bit to be sent with your data bits. The options are **None**, Even, Odd, Mark and Space.

Stop Bits

A stop bit indicates the end of a serial data packet. Select 1 Stop Bit for standard serial data communication. Select 2 Stop Bits if slower devices are used. The options are **1** and 2.

Flow Control

Use this feature to set the flow control for Console Redirection to prevent data loss caused by buffer overflow. Send a "Stop" signal to stop sending data when the receiving buffer is full. Send a "Start" signal to start sending data when the receiving buffer is empty. The options are **None** and Hardware RTS/CTS.

VT-UTF8 Combo Key Support

Select Enabled to enable VT-UTF8 Combination Key support for ANSI/VT100 terminals. The options are **Enabled** and Disabled.

Recorder Mode

Select Enabled to capture the data displayed on a terminal and send it as text messages to a remote server. The options are **Disabled** and Enabled.

Resolution 100x31

Select Enabled for extended-terminal resolution support. The options are Disabled and **Enabled**.

Legacy OS Redirection Resolution

Use this feature to select the number of rows and columns used in Console Redirection for legacy OS support. The options are 80x24 and **80x25**.

Putty KeyPad

This feature selects Function Keys and KeyPad settings for Putty, which is a terminal emulator designed for the Windows OS. The options are **VT100**, LINUX, XTERMR6, SCO, ESCN, and VT400.

Redirection After BIOS Post

Use this feature to enable or disable legacy Console Redirection after BIOS POST. When set to Bootloader, legacy Console Redirection is disabled before booting the OS. When set to Always Enable, legacy Console Redirection remains enabled when booting the OS. The options are **Always Enable** and Bootloader.

Serial Port for Out-of-Band Management/Windows Emergency Management Services (EMS)

The submenu allows the user to configure Console Redirection settings to support Out-of-Band Serial Port management.

EMS (Emergency Management Services) Console Redirection

Select Enabled to use a COM port selected by the user for EMS Console Redirection. The options are Enabled and **Disabled**.

****If the item above set to Enabled, the following items will become available for user's configuration:***

► EMS Console Redirection Settings

This feature allows the user to specify how the host computer will exchange data with the client computer, which is the remote computer used by the user.

Out-of-Band Management Port

The feature selects a serial port in a client server to be used by the Microsoft Windows Emergency Management Services (EMS) to communicate with a remote host server. The options are **COM1** and COM2/SOL.

Terminal Type

Use this feature to select the target terminal emulation type for Console Redirection. Select VT100 to use the ASCII character set. Select VT100+ to add color and function key support. Select ANSI to use the extended ASCII character set. Select VT-UTF8 to use UTF8 encoding to map Unicode characters into one or more bytes. The options are ANSI, VT100, VT100+, and **VT-UTF8**.

Bits Per Second

This item sets the transmission speed for a serial port used in Console Redirection. Make sure that the same speed is used in the host computer and the client computer. A lower transmission speed may be required for long and busy lines. The options are 9600, 19200, 57600, and **115200** (bits per second).

Flow Control

Use this item to set the flow control for Console Redirection to prevent data loss caused by buffer overflow. Send a "Stop" signal to stop sending data when the receiving buffer is full. Send a "Start" signal to start sending data when the receiving buffer is empty. The options are **None**, Hardware RTS/CTS, and Software Xon/Xoff.

The setting for each of these features is displayed:

Data Bits, Parity, Stop Bits

► Trusted Computing (Available when a TPM device is installed and detected by the BIOS)

Configuration

Security Device Support

If this feature and the TPM jumper on the motherboard are both set to Enabled, onboard security devices will be enabled for TPM support to enhance data integrity and network security. Please reboot the system for a change on this setting to take effect. The options are Enabled and **Disabled**.

TPM State

Select Enabled to use TPM (Trusted Platform Module) settings to enhance system data security. Please reboot your system for any change on the TPM state to take effect. The options are Disabled and **Enabled**.

Pending Operation

Use this item to schedule a TPM-related operation to be performed by a security device for system data integrity. Your system will reboot to carry out a pending TPM operation. The options are **0**, Enable Take Ownership, Disable Take Ownership, and TPM Clear.



Note: Your system will reboot to carry out a pending TPM operation. For more information on TPM, please refer to the TPM manual at <http://www.supermicro.com/manuals/other/TPM.pdf>.

Current Status Information

This item displays the status of the TPM support on this motherboard.

▶ ACPI Settings

WHEA Support

Select Enabled to support the Windows Hardware Error Architecture (WHEA) platform and provide a common infrastructure for the system to handle hardware errors within the Windows OS environment to reduce system crashes and to enhance system recovery and health monitoring. The options are Enabled and **Disabled**.

4-4 Event Logs

Use this menu to configure Event Log settings.

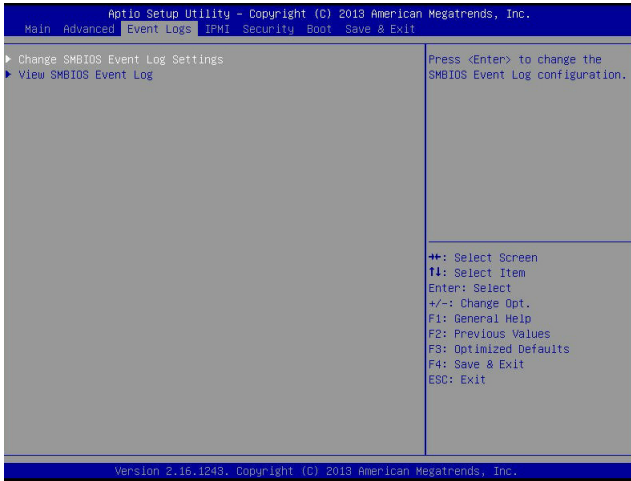

► Change SMBIOS Event Log Settings

This feature allows the user to configure SMBIOS Event settings.

Enabling/Disabling Options

SMBIOS Event Log

Select Enabled to enable SMBIOS (System Management BIOS) Event Logging during system boot. The options are **Enabled** and Disabled.

Runtime Error Logging Support

Select Enabled to support Runtime Error Logging. The options are Enable and **Disable**. If this item is set to Enable, the following item will be available for configuration:

Memory Corrected Error Enabling (Available when the item above-Runtime Error Logging Support is set to Enable)

Select Enable for the BIOS to correct a memory error if it is correctable. The options are Enable and **Disable**.

PCI-Ex (PCI-Express) Error Enable

Select Yes for the BIOS to correct errors occurred in the PCI-E slots. The options are Yes and **No**.

Memory Correctable Error Threshold

Use this item to enter the threshold value for correctable memory errors. The default setting is **10**.

Erasing Settings

Erase Event Log

Select Enabled to erase all error events in the SMBIOS (System Management BIOS) log before an event logging is initialized at bootup. The options are **No** and Yes.

When Log is Full

Select Erase Immediately to immediately erase all errors in the SMBIOS event log when the event log is full. Select Do Nothing for the system to do nothing when the SMBIOS event log is full. The options are **Do Nothing** and Erase Immediately.

SMBIOS Event Log Standard Settings

Log System Boot Event

Select Enabled to log system boot events. The options are **Disabled** and Enabled.

MECI (Multiple Event Count Increment)

Enter the increment value for the multiple event counter. Enter a number between 1 to 255. The default setting is **1**.

METW (Multiple Event Count Time Window)

This item is used to determine how long (in minutes) should the multiple event counter wait before generating a new event log. Enter a number between 0 to 99. The default setting is **60**.



Note: Please reboot the system for the changes to take effect.

View System Event Log

This item allows the user to view the event in the system event log. Select this item and press <Enter> to view the status of an event in the log.

Date/Time/Sensor/Type

4-5 IPMI

Use this menu to configure Intelligent Platform Management Interface (IPMI) settings.

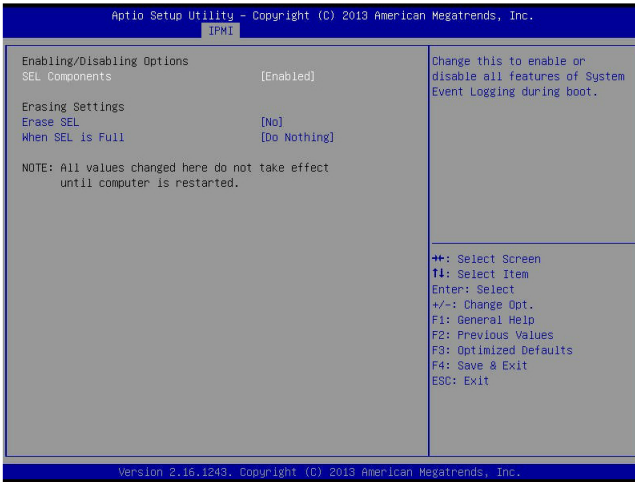

IPMI Firmware Revision

This item indicates the IPMI firmware revision used in your system.

IPMI Status

This item indicates the status of the IPMI firmware installed in your system.

► System Event Log

Enabling/Disabling Options

SEL Components

Select Enabled for all system event logging at bootup. The options are **Enabled** and Disabled.

Erasing Settings

Erase SEL

Select Yes, On next reset to erase all system event logs upon next system reboot.
 Select Yes, On every reset to erase all system event logs upon each system reboot.
 Select No to keep all system event logs after each system reboot. The options are **No**, Yes, On next reset, and Yes, On every reset.

When SEL is Full

This feature allows the user to determine what the BIOS should do when the system event log is full. Select Erase Immediately to erase all events in the log when the system event log is full. The options are **Do Nothing** and Erase Immediately.



Note: After making changes on a setting, be sure to reboot the system for the changes to take effect.

► BMC Network Configuration

The following items will be displayed:

IPMI LAN Selection

This item displays the IPMI LAN setting. The default setting is **Failover**.

IPMI Network Link Status

This item displays the IPMI Network Link status. The default setting is **Shared LAN**.

Update IPMI LAN Configuration

Select Yes for the BIOS to implement all IP/MAC address changes at the next system boot. The options are **No** and Yes

Configuration Address Source

Use this item to select the source of the IP address for this computer. If Static is selected, you will need to know the IP address of this computer and enter it to the system manually in the field. If DHCP is selected, the BIOS will search for a DHCP (Dynamic Host Configuration Protocol) server in the network that is attached to and request the next available IP address for this computer. The options are **DHCP** and Static.

The following items are assigned IP addresses automatically if DHCP is selected, or they can be configured manually if Static is selected.

Station IP Address

This item displays the Station IP address for this computer. This should be in decimal and in dotted quad form (i.e., 192.168.10.253).

Subnet Mask

This item displays the sub-network that this computer belongs to. The value of each three-digit number separated by dots should not exceed 255.

Station MAC Address

This item displays the Station MAC address for this computer. Mac addresses are six two-digit hexadecimal numbers.

Gateway IP Address

This item displays the Gateway IP address for this computer. This should be in decimal and in dotted quad form (i.e., 192.168.10.253).

4-6 Security Settings

Use this menu to configure security settings.



Password Check

Select Setup for the system to check for a password at Setup. Select Always for the system to check for a password at bootup or upon entering the BIOS Setup utility. The options are **Setup** and Always.

Administrator Password

Use this feature to set the administrator password which is required to enter the BIOS setup utility. The length of the password should be from 3 characters to 20 characters long.

4-7 Boot Settings

Use this menu to configure boot settings.

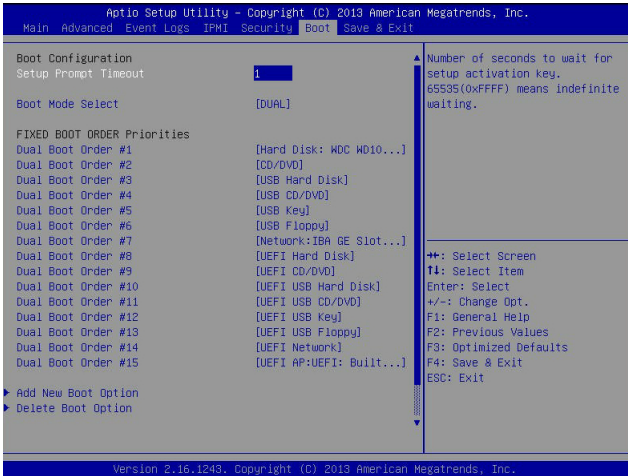

Setup Prompt Timeout

Use this item to indicate the length of time (the number of seconds) for the BIOS to wait before rebooting the system when the setup activation key is pressed. Enter the value of 65535 (0xFFFF) for the BIOS to wait indefinitely. The default setting is 1.

Boot Mode Select

Use this item to select the type of device that the system is going to boot from. The options are Legacy, UEFI, and **Dual**.

Fixed Boot Order Priorities

This option prioritizes the order of bootable devices that the system to boot from. Press <Enter> on each entry from top to bottom to select devices.

- Dual Boot Order #1
- Dual Boot Order #2
- Dual Boot Order #3
- Dual Boot Order #4
- Dual Boot Order #5
- Dual Boot Order #6

- Dual Boot Order #7
- Dual Boot Order #8
- Dual Boot Order #9
- Dual Boot Order #10
- Dual Boot Order #11
- Dual Boot Order #12
- Dual Boot Order #13
- Dual Boot Order #14
- Dual Boot Order #15

Add New Boot Option

This feature allows the user to add a new boot option to system boot priority features.

Add Boot Option

Use this item to specify the name of the driver that the new boot option is added to.

Path for Boot Option

This item is used to specify the path to the driver that the new boot option is added to. The format for the path is "fsx:\path\filename.efi".

Boot Option File Path

Create

After the driver option name and the file path are set, press <Enter> to enter to submenu and click OK to create the new boot option drive.

▶Delete Boot Option

Use this item to select a boot device to delete from the boot priority list.

Delete Boot Option

Select the target boot device to delete.

4-8 Save & Exit

Select the Save & Exit tab from the BIOS setup screen to configure the settings below.

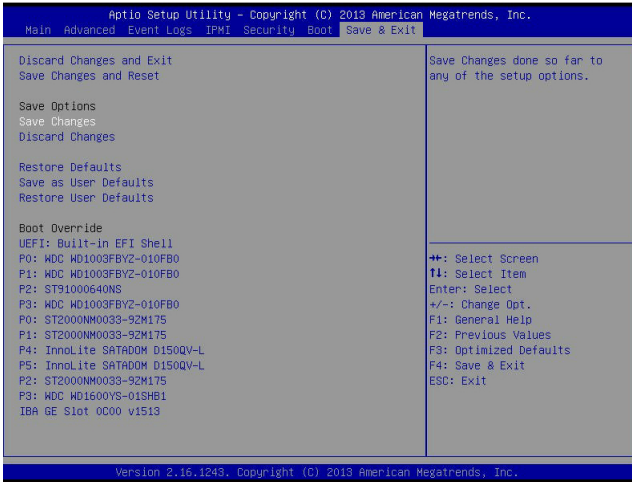

Discard Changes and Exit

Select this option to quit the BIOS setup without making any permanent changes to the system configuration, and reboot the computer. Select Discard Changes and Exit from the Exit menu and press <Enter>.

Save Changes and Reset

When you have completed the system configuration changes, select this option to leave the BIOS setup utility and reboot the computer for the new system configuration parameters to take effect. Select Save Changes and Exit from the Exit menu and press <Enter>.

Save Options

Save Changes

When you have completed the system configuration changes, select this option to save all changes made. This will not reset (reboot) the system.

Discard Changes

Select this option and press <Enter> to discard all the changes and return to the AMI BIOS Utility Program.

Restore Defaults

To set this feature, select Restore Defaults from the Exit menu and press <Enter>. These are factory settings designed for maximum system performance but not for maximum stability.

Save As User Defaults

To set this feature, select Save as User Defaults from the Exit menu and press <Enter>. This enables the user to save any changes to the BIOS setup for future use.

Restore User Defaults

To set this feature, select Restore User Defaults from the Exit menu and press <Enter>. Use this feature to retrieve user-defined settings that were saved previously.

Boot Override

This feature allows the user to override the Boot Option Priorities sequence in the Boot menu, and immediately boot the system with another device specified by the user. This is a one-time override.

Appendix A

UEFI BIOS Error Beep Codes

During the POST (Power-On Self-Test) routines, which are performed each time the system is powered on, errors may occur.

Non-fatal errors are those which, in most cases, allow the system to continue with bootup. The error messages normally appear on the screen.

Fatal errors will not allow the system to continue to bootup. If a fatal error occurs, you should consult with your system manufacturer for possible repairs.

These fatal errors are usually communicated through a series of audible beeps. The numbers on the fatal error list correspond to the number of beeps for the corresponding error.

For more information, please refer to the BIOS Error Post (Beep) Codes at https://www.supermicro.com/manuals/other/AMI_BIOS_POST_Codes_for_Grantley_Motherboards.pdf.

A-1 BIOS Error Beep Codes

BIOS Error Beep Codes		
Beep Code/LED	Error Message	Description
1 beep	Refresh	Circuits have been reset. (Ready to power up)
5 short beeps + 1 long beep	Memory error	No memory detected in the system
8 beeps	Display memory read/write error	Video adapter missing or with faulty memory
OH LED On	System OH	System Overheat

Notes

Appendix B

Software Installation Instructions

B-1 Installing Software Programs

The Supermicro FTP site contains drivers and utilities for your system at <https://www.supermicro.com/wftp/driver>. Some of these must be installed, such as the chipset driver.

After accessing the FTP site, go into the CDR_Images directory and locate the ISO file for your motherboard. Download this file to create a CD/DVD of the drivers and utilities it contains. (You may also use a utility to extract the ISO file if preferred.)

Another option is to go to the Supermicro website at <http://www.supermicro.com/products/>. Find the product page for your motherboard here, where you may download individual drivers and utilities.

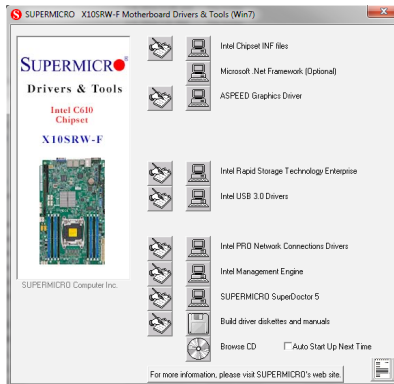

Driver/Tool Installation Display Screen



Note 1: Click the icons showing a hand writing on paper to view the readme files for each item. Click the computer icons to the right of these items to install each item (from top to bottom) one at a time. **After installing each item, you must re-boot the system before moving on to the next item on the list.** The bottom icon with a CD on it allows you to view the entire contents.

Note 2: When making a storage driver diskette by booting into a Driver CD, please set the SATA Configuration to "Compatible Mode" and configure SATA as IDE in the BIOS Setup. After making the driver diskette, be sure to change the SATA settings back to your original settings.

B-2 Installing SuperDoctor5

The Supermicro SuperDoctor® 5 is a hardware monitoring program that functions in a command-line or web-based interface in Windows and Linux operating systems. The program monitors system health information such as CPU temperature, system voltages, system power consumption, fan speed, and provides alerts via email or Simple Network Management Protocol (SNMP).

SuperDoctor 5 comes in local and remote management versions and can be used with Nagios to maximize your system monitoring needs. With SuperDoctor 5 Management Server (SSM Server), you can remotely control power on/off and reset chassis intrusion for multiple systems with SuperDoctor 5 or IPMI. SD5 Management Server monitors HTTP, FTP, and SMTP services to optimize the efficiency of your operation.



Note: The default User Name and Password for SuperDoctor 5 is admin/admin.

SuperDoctor 5 Interface Display Screen (Health Information)



Note: The SuperDoctor 5 program and User's Manual can be downloaded from the Supermicro web site at http://www.supermicro.com/products/nfo/sms_sd5.cfm.

Appendix C

UEFI BIOS Recovery Instructions

Warning: Do not upgrade the BIOS unless your system has a BIOS-related issue. Flashing the wrong BIOS can cause irreparable damage to the system. In no event shall Supermicro be liable for direct, indirect, special, incidental, or consequential damages arising from a BIOS update. If you need to update the BIOS, do not shut down or reset the system while the BIOS is updating to avoid possible boot failure.

C-1 An Overview to the UEFI BIOS

The Unified Extensible Firmware Interface (UEFI) provides a software-based interface between the operating system and the platform firmware in the pre-boot environment. The UEFI specification supports an architecture-independent mechanism for add-on card initialization to allow the UEFI OS loader, which is stored in the add-on card, to boot the system. The UEFI offers a clean, hands-off control to a computer system at bootup.

C-2 How to Recover the UEFI BIOS Image (-the Main BIOS Block)

A UEFI BIOS flash chip consists of a recovery BIOS block and a main BIOS block (a main BIOS image). The boot block contains critical BIOS codes, including memory detection and recovery codes for the user to flash a new BIOS image if the original main BIOS image is corrupted. When the system power is on, the boot block codes execute first. Once it is completed, the main BIOS code will continue with system initialization and bootup.



Note: Follow the BIOS recovery instructions below for BIOS recovery when the main BIOS boot crashes. However, when the BIOS boot block crashes, you will need to follow the procedures below for BIOS recovery.

C-3 To Recover the Main BIOS Block Using a USB-Attached Device

This feature allows the user to recover a BIOS image using a USB-attached device without additional utilities used. A USB flash device such as a USB Flash Drive, or a USB CD/DVD ROM/RW device can be used for this purpose. However, a USB Hard Disk drive cannot be used for BIOS recovery at this time.

The file system supported by UEFI is FAT (including FAT12, FAT16, and FAT32) installed on a bootable or non-bootable USB-attached device. However, the BIOS might need several minutes to locate the SUPER.ROM file if the media size becomes too large because it contains too many folders and files.

To perform UEFI BIOS recovery using a USB-attached device, follow the instructions below.

1. Using a different machine, copy the "Super.ROM" binary image file into the disc Root "\\" Directory of a USB device or a writable CD/DVD.

 **Note:** If you cannot locate the "Super.ROM" file in your driver disk, visit our website at www.supermicro.com to download the BIOS image into a USB flash device and rename it "Super.ROM" for BIOS recovery use.

2. Insert the USB device that contains the new BIOS image ("Super.ROM") into your USB drive and power on the system
3. While powering on the system, please keep pressing <Ctrl> and <Home> simultaneously on your keyboard *until the following screen (or a screen similar to the one below) displays.*

Warning!! Please **stop** pressing the <Ctrl> and <Home> keys immediately when you see the screen (or a similar screen) below; otherwise, it will trigger a system reboot.



 **Note:** On the other hand, if the following screen displays, please load the "Super.ROM" file to the root folder and connect this folder to the system. (You can do so by inserting a USB device that contains the new "Super.ROM" image to your machine for BIOS recovery.)



- After locating the new BIOS binary image, the system will enter the BIOS Recovery menu as shown below.



Note: At this point, you may decide if you want to start with BIOS recovery. If you decide to proceed with BIOS recovery, follow the procedures below.

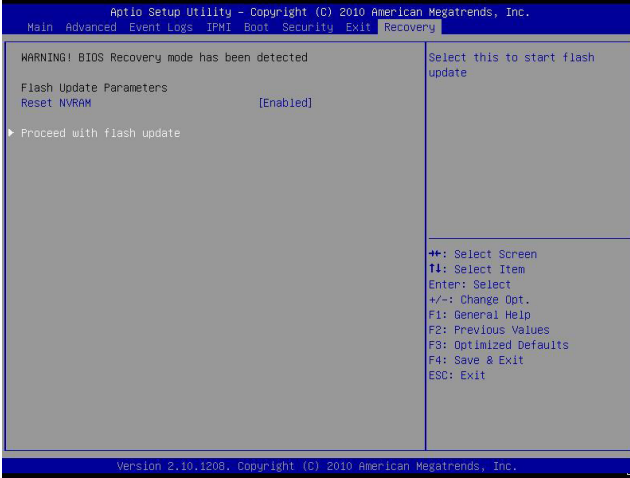

- When the screen as shown above displays, using the arrow key, select the item "Proceed with flash update" and press the <Enter> key. You will see the progress of BIOS recovery as shown in the screen below.



Note: Do not interrupt the process of BIOS flashing until it is completed.

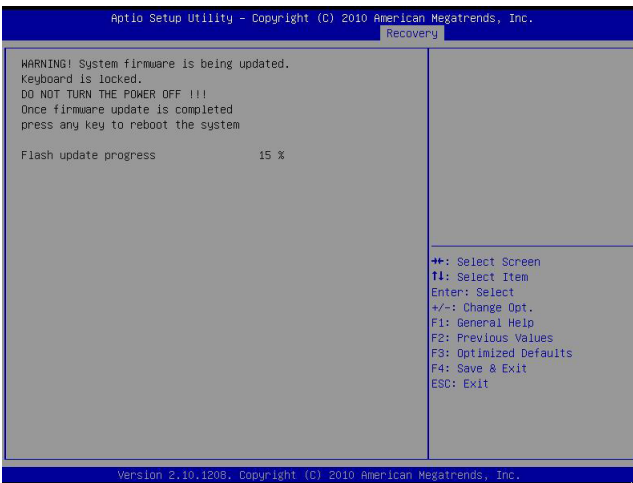

- After the process of BIOS recovery is completed, press any key to reboot the system.

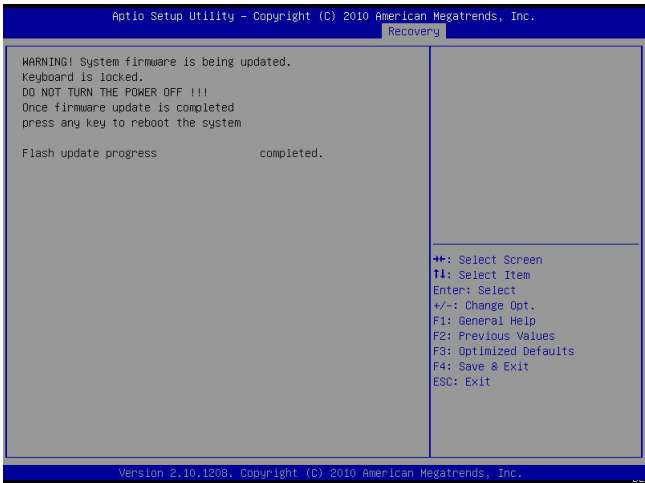

- Using a different system, extract the BIOS package into a bootable USB flash drive.
- When a DOS prompt appears, enter FLASH.BAT BIOSName.### at the prompt.



Note: Do not interrupt this process until BIOS flashing is completed.

- After seeing the message that BIOS update is completed, unplug the AC power cable from the power supply to clear the CMOS, and then plug the AC power cable in the power supply again to power on the system.
- Press continuously to enter the BIOS Setup utility.
- Press <F3> to load default settings.
- After loading default settings, press <F4> to save the settings and exit the BIOS Setup utility.

Appendix D

Dual Boot Block on Grantley Platforms

Overview

On X10 Grantley platforms, Supermicro introduces the Dual Boot Block feature that revives the system from an inert state if the primary boot block in the ROM chip is damaged. A boot block carries critical codes to boot the system with minimum hardware requirements for the BIOS recovery flash.

In the previous generation platforms, there is an onboard jumper called JBR1 to activate the secondary boot block in the ROM chip. However, it is not convenient for data centers and enterprises.

This document describes how to enable the BIOS recovery flash by using the Dual Boot Block feature through IPMI GUI browser and IPMI Command Sets on the X10 Grantley platforms.

Before Startup

A USB flash drive with FAT32 file system and Super.ROM stored are required, and the USB flash drive does not need to be bootable. IPMI firmware that is capable of supporting BIOS Resilience function in IPMI browser and of mounting virtual media via OEM CMDs is required, too. The SMCIPMITool is needed if Dual Boot Block is activated by IPMI Command Sets as stated in Section D-2.

When to Use Dual Boot Block

The primary dual block can get corrupted when it is flashing and encounters a power outage. The system does not respond nor output video at all after power-on. The secondary boot block can be activated to kick in the BIOS recovery flash.

How to Use Dual Boot Block

Two methods on how to use the Dual Boot Block feature are introduced in the following pages:

1. Through the IPMI GUI Browser
2. Through the IPMI Command Sets

These are user-attended operations. IPMI logic on the defective system has to be alive and functioning. IPMI IP is known to the user.

D-1 IPMI GUI Browser

To perform the Dual Boot Block through the IPMI GUI browser, follow the instructions below:

1. After the IPMI GUI browser log-in, click on the Miscellaneous tab, then BIOS Resilience, then the Resile button.

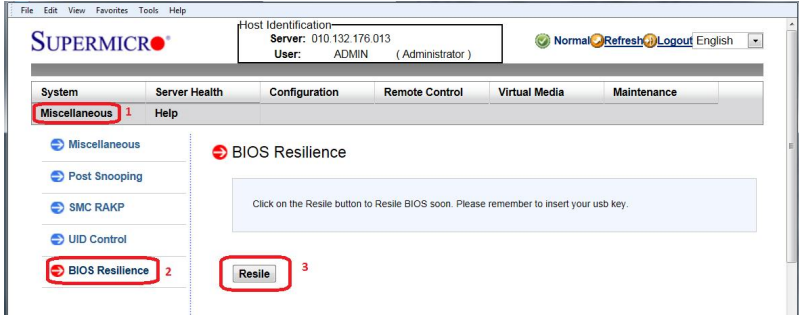

2. IPMI prints out a message that indicates the secondary boot block activation. If the system is on, IPMI forces it to shut down.

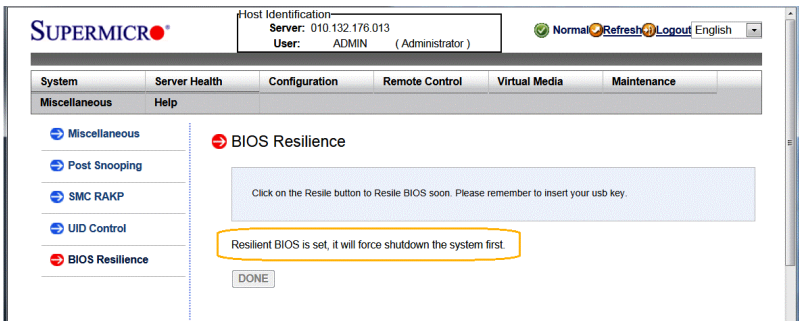

- 3. Click on the **Remote Control** tab, then Console Redirection, then the **Launch Console** button to open the Java iKVM Viewer.

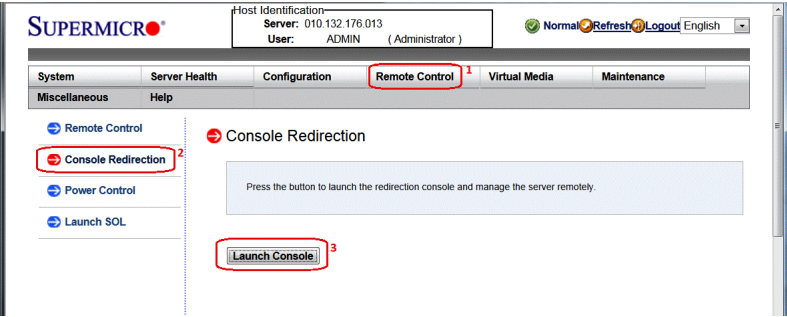

- 4. In the Java iKVM Browser, click on the **Virtual Media** tab, then **Virtual Storage** to open the Virtual Media Loader.

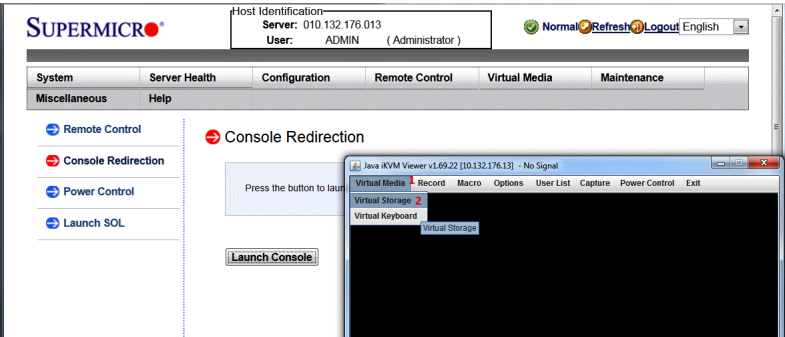

- In the Virtual Media loader, click on the **Device1** tab, then **Logical Drive Type** drop-down menu, then select the USB flash drive with Super.ROM. Click **Plug In**, then **OK**.

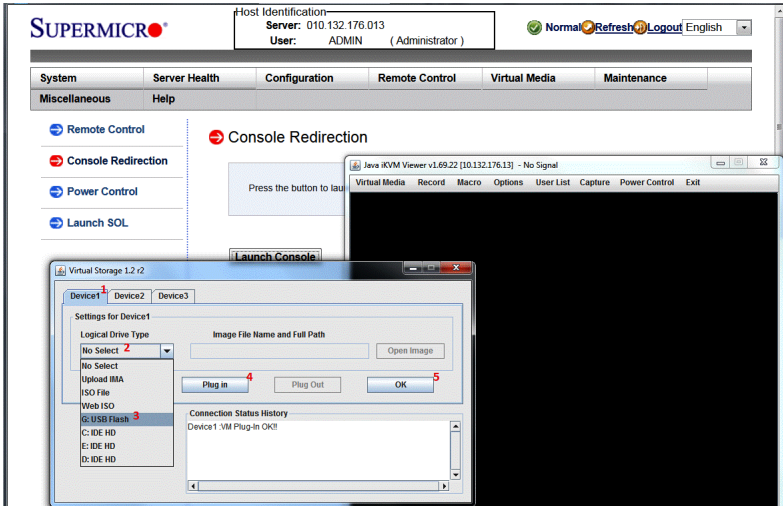

- Click on the **Remote Control** tab, then **Power Control**, then check the **Power On Server** button. Click on the **Perform Action** button to power up the system.

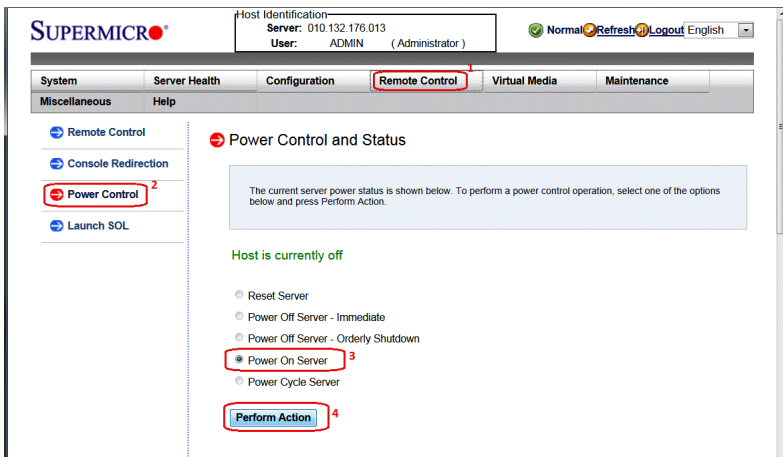

- 7. After the system powers on, the secondary boot block starts to initialize the essential hardware components and locates Super.ROM in the USB flash drive, which was mounted earlier. If Super.ROM is found, the on-duty boot block boots to it and finishes the rest of the POST processes. The system will automatically enter the BIOS recovery flash page in Setup at the end of POST. Move the cursor to **Proceed with flash update** and press **ENTER**.

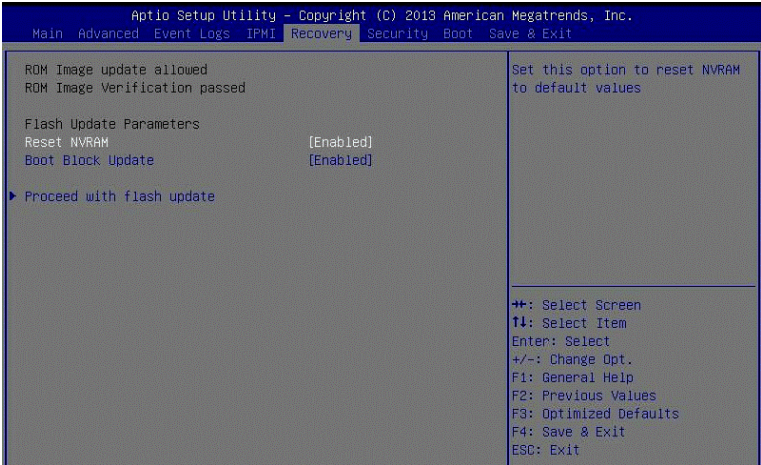

- 8. The BIOS recovery flash begins and programs the boot blocks as well as the main block.

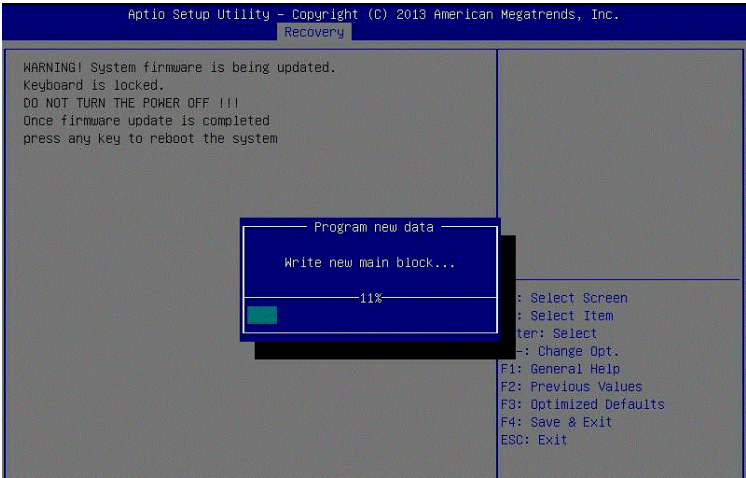

- A message box will appear to indicate the BIOS recovery flash process is complete. Press **ENTER** to finish. The system will do a power cycle to deactivate the dual boot block feature and produce a normal BIOS POST.

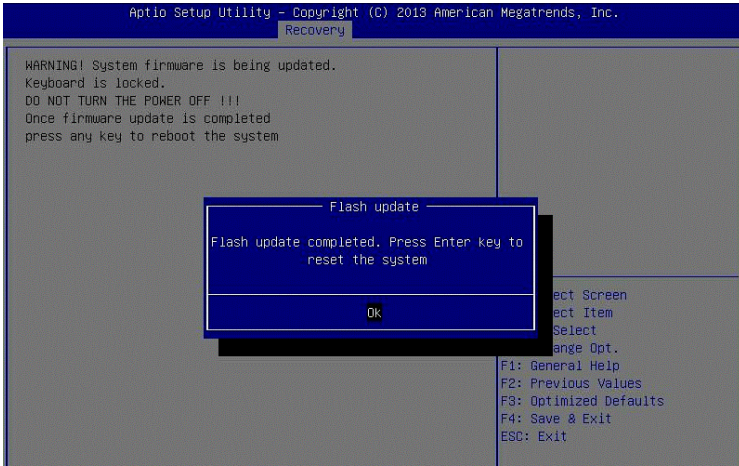

D-2 IPMI Command Sets

To perform the Dual Boot Block through the IPMI Command Sets, follow the instructions below:

1. After the IPMI GUI browser log-in, click on the **Remote Control** tab, then **Console Redirection**, then the **Launch Console** button to open Java iKVM Viewer.

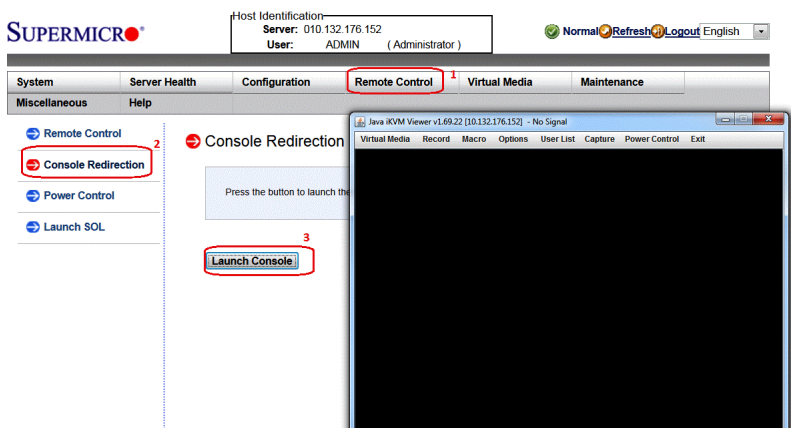

2. Open a DOS command prompt for SMCIIIPMITool execution. Type **ipmi power down** to power off the defective system.

```

C:\Administrator: C:\Windows\system32\cmd.exe
D:\SMCIIPMITool_2.9.2_jar_20140423>java -jar SMCIIIPMITool.jar 10.132.176.152 ADMIN
ADMIN ipmi power down
Done

```

3. Enable BIOS Resilience mode in remote IPMI and confirm.

- To enable, type the following command in the command prompt:
ipmi raw 30 70 C2 D5 00 00
- To confirm, type the following command in the command prompt:
ipmi raw 30 70 C3 D5

```

Administrator: C:\Windows\system32\cmd.exe
D:\SMCIPMITool_2.9.2_jar_20140423>java -jar SMCIPMITool.jar 10.132.176.152 ADMIN
ADMIN ipmi raw 30 70 C2 D5 00 00 Enable BIOS Resilience mode
00 == complete code

D:\SMCIPMITool_2.9.2_jar_20140423>java -jar SMCIPMITool.jar 10.132.176.152 ADMIN
ADMIN ipmi raw 30 70 C3 D5 Check BIOS Resilience mode
00 == Enabled
    
```

4. Mount the USB flash drive with Super.ROM to remote Virtual Media Device 1. This must be done in the IPMI Shell mode.

- To enter the IPMI Shell mode, type: **shell**
- To see the list of drives, type: **vmwa dev1list**
- To mount the drive, type: **vmwa dev1drv 2**.
In this example, the USB flash drive is drive #2 (drv 2). Drive numbers may vary in each system.
- To confirm if the drive is mounted, type: **vmwa status**

```

Administrator: C:\Windows\system32\cmd.exe - java -jar SMCIPMITool.jar 10.132.176.152 ADMIN AD...
D:\SMCIPMITool_2.9.2_jar_20140423>java -jar SMCIPMITool.jar 10.132.176.152 ADMIN
ADMIN shell Enter IPMI shell mode
SMC IPMI Tool U2.9.2(Build 140423) - Super Micro Computer, Inc.
Press Ctrl+D or "exit" to exit
Press "?" or "help" for help
Press TAB for command completion
Press UP and DOWN key for command history
Trap Receiver Started
10.132.176.152 X10DRW-i(T) <S5/G2> 21:13 ASPD_I>vmwa dev1list Browse what to mount
2: IG: USB Flash USB key with Super.ROM
3: IC: IDE HDJ
4: ID: IDE HDJ

10.132.176.152 X10DRW-i(T) <S5/G2> 21:13 ASPD_I>vmwa dev1drv 2
Mounting G: USB Flash Mount Index 2 to remote virtual media device 1
Device 1 :UM Plug-In OK!!

10.132.176.152 X10DRW-i(T) <S5/G2> 21:13 ASPD_I>vmwa status Confirming
Device 1: G: USB Flash
Device 2: None
    
```

5. Power on the remote system for BIOS recovery flash.

- To power on, type: **ipmi power up**

After the system powers on, the secondary boot block initializes the essential hardware components and locates Super.ROM in the USB flash drive, which are the same as Steps 7-9 in Section D-1.

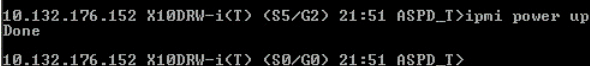

```
10.132.176.152 X10DRW-i(T) <S5/G2> 21:51 ASPD_T>ipmi power up
Done
10.132.176.152 X10DRW-i(T) <S0/G0> 21:51 ASPD_T>
```

User Approach

Dual Boot Block is not designed for an automatic operation, non user-attended operation. The feature offers an immediate resilience after a BIOS upgrade somehow stops upon flashing the on-duty boot block. For a BIOS upgrade on multi-node, SUM is recommended. Please contact your Field Application Engineer representative for an understanding of the SUM product.

Notes

(Disclaimer Continued)

The products sold by Supermicro are not intended for and will not be used in life support systems, medical equipment, nuclear facilities or systems, aircraft, aircraft devices, aircraft/emergency communication devices or other critical systems whose failure to perform be reasonably expected to result in significant injury or loss of life or catastrophic property damage. Accordingly, Supermicro disclaims any and all liability, and should buyer use or sell such products for use in such ultra-hazardous applications, it does so entirely at its own risk. Furthermore, buyer agrees to fully indemnify, defend and hold Supermicro harmless for and against any and all claims, demands, actions, litigation, and proceedings of any kind arising out of or related to such ultra-hazardous use or sale.